

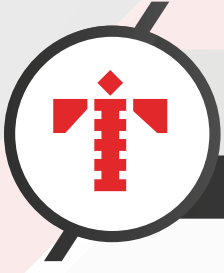

“Yüksek Kalitenin Güvenini Yaşayın”
“Experience The Confidence Of High Quality”



HAKKIMIZDA

ABOUT US

1995 yılında ticari faaliyetlerine başlayan İrtu Elektrik Malzemeleri Sanayi ve Ticaret Limited Şirketi elektrik sektöründe Alçak Gerilim Pano imalatında taşıyıcı baraları mesnetlemede kullanılan her tür izolatörü cam elyaf takviyeli polyster (BMC) ve yanmaz (V0) plastik malzemeden imal ederek pano sektöründe hizmet vermektedir.

İlave olarak kablo pabuçları, dağıtıcı üniteler, nötr topraklama klemensleri ve diğer pano aksesuarları konusunda da müşterilerin ihtiyaçlarını karşılamaktadır.

Ana ürün yelpazesinin dışında ortam koşullarına dayanıklı, esnek, yüksek mekanik dayanımlı cam elyafın bir araya getirilmesi ile üretilen; yüksek özgül mukavemet ve ısı özellikler, elastikiyet, hafiflik, mükemmel dielektrik nitelikler, kalıplama ve tasarım esnekliği sağlayan BMC çalışmaları ile de elektrik sektörüne hizmet vermektedir. Bunlardan bazıları; kaynak penseleri, varyak kursörleri, benzinli araç distrübütör kapakları, sigorta destek profilleridir.

Müşteri memnuniyetini en üst seviyede tutma hedefi doğrultusunda. Kalite ile özdeşleşmiş bir firma olarak, hizmet standartlarının gelişimi, güvenli, hızlı hizmet ve ürünün her defasında hatasız sunulması, sürekli eğitimin devamlılığı, uyguladığımız öncelikli ve vazgeçilmez prensiplerimizdir. Bu prensipler doğrultusunda firmamız, marka tescil ve ISO9001:2000 belgesi ile; ürünlerimizi de 50kA-65kA-80kA tip testi, 3kV testi, kızaran tel testi ile belgelenmiştir.

Misyonumuz; alçak gerilim pano imalatında dahili ortamda bakır baraları bir kaideye monte etmek amaçlı kullanılan mesnet izolatör üretimini gerçekleştirmekdir. Ayrıca diğer pano sarf ürünlerini üretim ve tedarigini sağlamaktır.

Vizyonumuz; pano sektöründen gelen talepler doğrultusunda ihtiyaçların bilimsel temellere dayalı, hızlı ve yerinde çözümler ile giderilmesi için gerekli ürünleri geliştirmek ve bu sayede müşterilerimiz ile on yıllara dayalı dostluk ve iş birliği oluşturmak A sınıfı tedarikçisi ve çözüm ortağı olmaktır.

Saygılarımızla.





INDEX

İÇİNDEKİLER

"YÜKSEK KALİTENİN GÜVENİNİ YAŞAYIN"

"EXPERIENCE THE CONFIDENCE OF HIGH QUALITY"

2	HAKKIMIZDA / ABOUT US	SİNYAL VE BUTON GRUPLARI / SIGNAL AND BUTTON GROUPS	56
4 - 6	POLYESTER MESNET İZOLATÖRLER / POLYESTER INDOOR TYPE INSULATORS	OTOMAT ETİKETLERİ VE KAPATMALARI / AUTOMAT LABEL AND COVER PLATES	57
7 - 11	POLYESTER TARAK İZOLATÖRLER / POLYESTER BUSBAR SUPPORT INSULATORS	PANO ETİKETLERİ / PANEL LABELS	58
14-15	PLASTİK MESNET İZOLATÖRLER / PLASTIC INDOOR TYPE INSULATORS	PVC VE SAC UYARI ETİKETLERİ / PVC AND SHEET METAL ATTANTION LABELS	59
16 - 23	PLASTİK TARAK İZOLATÖRLER / PLASTIC Busbar SUPPORT INSULATORS	MARKALAMA SİSTEMLERİ / MARKING SYSTEMS	60
24	PLASTİK GEÇİŞ İZOLATÖRLERİ / PLASTIC TRANSITION INSULATORS	BORU VE KABLO TAŞIMA APARATLARI / PIPE AND CABLE TRANSPORT EQUIPMENTS	61
26	BAĞLANTI APARATLARI / CONNECTION EQUIPMENTS	PANO SAC AKSESUARLARI / PANEL SHEET ACCESSORIES	62
28	UPGM EL YATIRMA CAM ELYAF PLAKALAR / UPGM HAND LAY UP FIBER GLASS PLATES	PROJE CEBİ VE HAVLANDIRMALAR / PROJECT PACK POCKET AND AIR CONDITIONINGS	63
29	UPGM SMC CAM ELYAF PLAKALAR / UPGM 203 SMC FIBER GLASS PLATES	PANO PİRİZLER , TERMOSTAT VE ISITICILAR / PANEL SOCKET, THERMOSTATS AND HEATERS	64
32	O.GERİLİM MESNET İZOLATÖRLER / M. VOLTAGE INDOOR TYPE INSULATORS	İZOLELİ YÜKSÜKLER / INSULATED CORN AND TERMINALS	66-69
33	TRAFİO BUSHİNG İZOLATÖRLER / TRANSFORMER BUSHİNG INSULATORS	KABLO PAPUÇLARI / CABLE LUGS	70-74
34	O.GERİLİM KABLO TUTUCU VE KÖRÜKLER / M. VOLTAGE CABLE HOLDER AND BELLOWS	KABLO TOPLAYICILAR / CABLE COLLECTORS	75
36-40	DAĞITICI ÜNİTELER / DISTRIBUTION UNITS	MAKARONLAR / SHRINK	76-77
41	GÜÇ DAĞITIM BLOKLARI / MONOBLOCK DISTRIBUTION UNITS	KABLO BAĞLARI / CABLE TIES	78
42	İZOLASYONLU TOPRAKLAMA KLEMENSLERİ / INSULATED PANEL GROUNDING TERMINALS	PANO İZOLASYON EKİPMANLARI / PANEL INSULATION EQUIPMENT	79
43-45	TOPRAKLAMA KLEMENSLERİ / GROUNDING TERMINALS	MONTAJ RAYLARI / PANEL MOUNTING RAIL	80
46	TOPRAKLAMA BARALARI / EARTING BARS	KABLO KANALLARI / CABLE TRUNKINGS	81
47	GÜÇ DAĞITIM BARASI / POWER DISTRIBUTION BUSBAR	RAKOR, SOMUN VE KÖR TAPALAR / BRASS CABLE GLAND, NUTS AND BLINDSTOPS	82-83
48	BAKIR BAĞLANTI KLEMENSLERİ / COPPER CONNECTION TERMINALS	SİRAL BORULAR VE ROKARLARI / SPIRAL CONDUIT ADN GLAND	84-86
48	BAKIR BARA VE U KLEMENSLERİ / COPPER BUSBAR U CLAMPS CONNECTION	AKIM TRAFOLARI / CURRENT TRANSFORMERS	88-92
49	FLEXİ BAĞLATI BARALARI / FLEXI CONNECTION BUS BARS	SIRA KLEMENSLER / TERMINALS STRIPS	94
50-52	MÜŞTEREK W OTOMAT BARALARI / JOIN W VENDING BUS BARS	SOKET KLEMENSLER / SOCKET CONNECTORS	95
54-55	LED AYDINLATMALAR / LED LIGHTINGS	TRAFİO VE STEATİT KLEMENSLER / TRANSFORMER AND STEATİT TERMINALS	96
		BUAT KLEMENSLER / PUSH IN WIRE CONNECTORS	97
		SİLİNDİRİK SİGORTALAR / CYLINDRICAL FUSES	98-99
		KABLO GEÇİŞ PLAKASI / CABLO INPUT PLATE	100-101



SERTİFİKALAR

CERTIFICATES

LVT Test Laboratuvarları Ltd. Şti.
DENEY RAPORU

METİN
Firma: İRTU ELEKTRONİKLER VE TE LİMİTİ

Adres: İSTANBUL, AYSIYI ÇİC ANKARA SAĞI-41 ÜRSÜLÜ YOLUNDA, ÜRSÜLÜ

Müşteri: İRTU ELEKTRONİKLER VE TE LİMİTİ

Deney No: FIBER GLASS PLANK

Makine: İRTU

Deney Tarihi: 20.09.2018 - 21.09.2018

Deney Saati: 09.00.00 - 17.00.00

Deney Yeri: İRTU

Deney Sonuçları:

Deney No	Deney Sonuçları	Laboratuvar Mühürü
1

LVT Test Laboratuvarları Ltd. Şti.
DENEY RAPORU

METİN
Firma: İRTU ELEKTRONİKLER VE TE LİMİTİ

Adres: İSTANBUL, AYSIYI ÇİC ANKARA SAĞI-41 ÜRSÜLÜ YOLUNDA, ÜRSÜLÜ

Müşteri: İRTU ELEKTRONİKLER VE TE LİMİTİ

Deney No: FIBER GLASS PLANK

Makine: İRTU

Deney Tarihi: 20.09.2018 - 21.09.2018

Deney Saati: 09.00.00 - 17.00.00

Deney Yeri: İRTU

Deney Sonuçları:

Deney No	Deney Sonuçları	Laboratuvar Mühürü
1

LVT Test Laboratuvarları Ltd. Şti.
DENEY RAPORU

METİN
Firma: İRTU ELEKTRONİKLER VE TE LİMİTİ

Adres: İSTANBUL, AYSIYI ÇİC ANKARA SAĞI-41 ÜRSÜLÜ YOLUNDA, ÜRSÜLÜ

Müşteri: İRTU ELEKTRONİKLER VE TE LİMİTİ

Deney No: FIBER GLASS PLANK

Makine: İRTU

Deney Tarihi: 20.09.2018 - 21.09.2018

Deney Saati: 09.00.00 - 17.00.00

Deney Yeri: İRTU

Deney Sonuçları:

Deney No	Deney Sonuçları	Laboratuvar Mühürü
1



POLYESTER (BMC) İZOLATÖRLER

Anma gerilimi 1000 V'a kadar olan Alçak Gerilim Mesnet İzolatörler dahil ortamlarda bakır barayı bir kaideye üzerine montaj etmek amacı ile kullanılan ürünlerdir. Mesnet izolatörler ürünlerin kullanıldıkları ortamlarda ana can damarlarından birisidir. Ortam koşullarına dayanıklı esnek, yüksek mekanik dayanımlı cam elyafının bir araya getirilmesi ile meydana getirilen: yüksek özgül mukavemet ve ısı özellikler, elastikiyet, hafiflik, mükemmel dielektrik nitelikler, kalıplama ve tasarım esnekliği sağlaya BMC malzemeden imal edilir.

Kimyasal özellikleri aşağıdaki gibidir:

- Cam elyaf takviyeli polyester, %18 elyaf ihtiva eder.
- Standart renk Irox red 130 (ihtiyaç halinde farklı renk uygulanabilir)
- Körsomunlar: çelik çinko kaplamalı (istek üzerine prinç malzeme)
- Civata: cr3 8.8 çelik civata.

Low tension post insulators, whose rated voltage can go up to 1000 V, are used to join a copper bar to a base in indoor.

Post insulators are the one of the most important element in where they used It is made of BMC material, which is manufactured by combining flexible, high mechanical strength glass fiber, providing high specific strength and thermal properties , excellent dielectric properties, molding and design flexibility.

It's chemical charecters are listed below:

- Fiber glass reinforced polyester, has 18% of fibers.
- Standard color, Irox red 130. (different colors can be applied if necessary)
- Cap Nuts : steel-zinc lined. (brass material can used if requested)
- Bolt: Cr3 8.8 steel bolt



Uygun Çalışma Sıcaklığı <i>Proper Operating Temperature</i>	Genel elektroteknik uygulaması Sıcaklık aralığı	<i>General electrotechnical application.</i> <i>Temperature range</i>	-40 °C to +130 °C	
Fiziksel Özellikler <i>Pyhsical Properties</i>	Cam elyaf oranı Özkütle Kalıp çekmesi Su emme	<i>Fiber Glass Ratio</i> <i>Density</i> <i>Moulding Shrinkage</i> <i>Water Absorption</i>	18% 1,75g/cm ³ <0,1% <0,2% (<25mg)	DIN 53479 DIN EN ISO 62
Mekanik Özellikler <i>Mechanical Properties</i>	Martens derecesi Bükülme dayanıklılığı Darbe dayanıklılığı	<i>Martens Degree</i> <i>Flexural Strength</i> <i>Impact Strength</i>	>200°C 90 N/mm ² 25-30 kJ/m ²	DIN 53462 DIN EN ISO 178 DIN EN ISO 179
Elektriksel Özellikler <i>Electrical Properties</i>	Yüzey direnci Elektrik öz direnci Dielectric dayanımı Alev alma dayanımı	<i>Surface Resistivity</i> <i>Volume Resistivity</i> <i>Dielectric Strength</i> <i>Flame Resistance</i>	10 ¹⁴ Ωcm 10 ¹⁴ Ωcm 150 kV/cm CTI 600	DIN IEC 60093 DIN IEC 60093 DIN EN 60243-1 DIN IEC 60112
Yanmazlık <i>Flammability</i>	Kızaran tel testi	<i>Glow –wire Flammability</i>	960° C	DIN EN 60695

Çift Taraf Saplmalı / Busbar Standoff insulators with Double side Screw

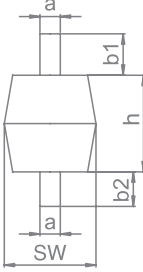

Kod / Code	Tip / Type	Ölçüler / Dimensions (mm)					Kullanım Voltajı Usage Voltage ~ kV	Test Voltajı Test Voltage ~ kV	Gerilim Direnci Voltage Resistance kN	Ağırlık Weight kg / box	Kutu Adedi / Box Qty.	Birim Fiyat Price (Adet/pcs)
		a1	b1	b2	SW	h						
İRTU-POLM1001	M5	5	12	12	22	24	0,6	3	0,75	11,00	500	33,10 TL
İRTU-POLM1002	M6	6	15	15	27	28	0,6	3	1,00	12,00	300	37,75 TL
İRTU-POLM1003	M8	8	16	19	40	40	1	3	2,50	10,50	100	64,10 TL
İRTU-POLM1004	M10	10	12	15	40	40	1	3	2,70	14,00	100	82,85TL

Saplmalı & Kör Somunlu / Busbar Standoff insulators with One Side Screw

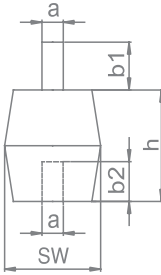

Kod / Code	Tip / Type	Ölçüler / Dimensions (mm)					Kullanım Voltajı Usage Voltage ~ kV	Test Voltajı Test Voltage ~ kV	Gerilim Direnci Voltage Resistance kN	Ağırlık Weight kg / box	Kutu Adedi / Box Qty.	Birim Fiyat Price (Adet/pcs)
		a1	b1	b2	SW	h						
İRTU-POLM1005	M5	5	12	12	22	24	0,6	3	0,75	10,50	500	39,75 TL
İRTU-POLM1006	M6	6	15	15	27	28	0,6	3	1,00	10,80	300	47,10 TL
İRTU-POLM1007	M8	8	16	15	40	40	1	3	2,50	9,80	100	73,80 TL
İRTU-POLM1008	M10	10	15	15	40	40	1	3	2,70	11,40	100	87,75 TL

Çift Taraf Kör Somunlu / Two sided blind standoff insulators

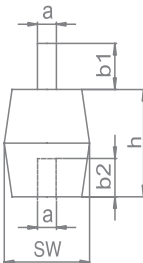

Kod / Code	Tip / Type	Ölçüler / Dimensions (mm)					Kullanım Voltajı Usage Voltage ~ kV	Test Voltajı Test Voltage ~ kV	Gerilim Direnci Voltage Resistance kN	Ağırlık Weight kg / box	Kutu Adedi / Box Qty.	Birim Fiyat Price (Adet/pcs)
		a1	b1	b2	SW	h						
İRTU-POLM1009	M5	5	9	9	22	24	0,6	3	0,75	10,00	500	44,85 TL
İRTU-POLM1010	M6	6	12	12	27	28	0,6	3	1,00	9,90	300	49,50 TL
İRTU-POLM1011	M8	8	15	15	40	40	1	3	2,50	8,80	100	73,65 TL
İRTU-POLM1012	M10	10	15	15	40	40	1	3	2,70	8,90	100	100,80 TL

Çift Taraf Kör Somunlu SW 30 / H 30 / Two sided blind standoff insulators SW30/H30

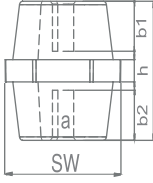

Kod / Code	Tip / Type	Ölçüler / Dimensions (mm)					Kullanım Voltajı ~ kV	Test Voltajı ~ kV	Gerilim Direnci kN	Ağırlık kg/1 box	Kutu Adedi / Box Qty.	Birim Fiyat Price (Adet/pcs)
		a1	b1	b2	SW	h						
İRTU-POLM303006	M6	6	11	11	30	30	1	3	4	6	100	73,40 TL
İRTU-POLM303008	M8	8	11	11	30	30	1	3	6	6,20	100	81,55 TL
İRTU-POLM303010	M10	10	11	11	30	30	1	3	6	6,50	100	88,50 TL

Çift Taraf Kör Somunlu SW 40 / H 40 / Two sided blind standoff insulators SW 40/H 40

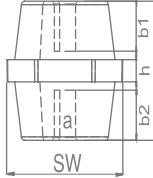

Kod / Code	Tip / Type	Ölçüler / Dimensions (mm)					Kullanım Voltajı ~ kV	Test Voltajı ~ kV	Gerilim Direnci kN	Ağırlık kg/1 box	Kutu Adedi / Box Qty.	Birim Fiyat Price (Adet/pcs)
		a1	b1	b2	SW	h						
İRTU-POLM404006	M6	6	11	11	40	40	1	3	6	10	100	
İRTU-POLM404008	M8	8	11	11	40	40	1	3	9	10,60	100	
İRTU-POLM404010	M10	10	11	11	40	40	1	3	9	10,80	100	

Çift Taraf Kör Somunlu SW 50 / H 50 / Two sided blind standoff insulators S50/H50

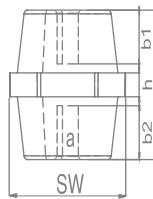

Kod / Code	Tip / Type	Ölçüler / Dimensions (mm)					Kullanım Voltajı ~ kV	Test Voltajı ~ kV	Gerilim Direnci kN	Ağırlık kg/1 box	Kutu Adedi / Box Qty.	Birim Fiyat Price (Adet/pcs)
		a1	b1	b2	SW	h						
İRTU-POLM1019	M8	8	15	15	50	50	1	3	9	20,00	100	116,00 TL
İRTU-POLM1020	M10	10	15	15	50	50	1	3	9	21,00	100	120,90 TL
İRTU-POLM1021	M12	12	15	15	50	50	1	3	10	22,00	100	137,85 TL

Çift Taraf Kör Somunlu SW 48 / H 76 / Two sided blind standoff insulators SW 48 / H 76

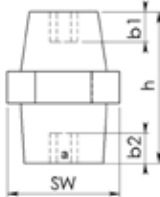

Kod / Code	Tip / Type	Ölçüler / Dimensions (mm)					Kullanım Voltajı ~ kV	Test Voltajı ~ kV	Gerilim Direnci kN	Ağırlık kg/1 box	Kutu Adedi / Box Qty.	Birim Fiyat Price (Adet/pcs)
		a1	b1	b2	SW	h						
İRTU-POLM487608	M8	8	15	15	48	76	1	3	10	23,50	50	155,15 TL
İRTU-POLM487610	M10	10	15	15	48	76	1	3	12	24,00	50	155,15 TL
İRTU-POLM487612	M12	12	15	15	48	76	1	3	12	25,00	50	155,15 TL

Çift Taraf Kör Somunlu 1N500 / Two sided blind standoff insulators 1N500

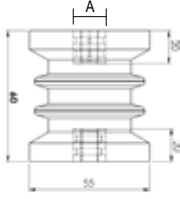

Kod / Code	Tip / Type	Somun Ölçüsü Nut Measure (A)	Kullanım Voltajı ~ kV	Test Voltajı ~ kV	Gerilim Direnci kN	Ağırlık kg/18 pcs	Kutu Adedi / Box Qty.	Birim Fiyat Price (Adet/pcs)
İRTU-POLM1016	1N500	M8	3	15	5,00	7,00	32	136,45 TL
İRTU-POLM1017	1N500	M10	3	15	5,00	7,00	32	138,00 TL
İRTU-POLM1018	1N500	M12	3	15	5,00	7,00	32	155,50 TL

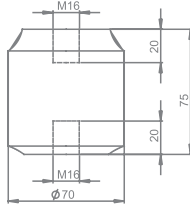

Çift Taraf Kör Somunlu / Two Sided Blind Standoff Insulators

Kod / Code	Tip / Type	Kullanım Voltajı ~ kV	Test Voltajı ~ kV	Gerilim Direnci kN	Ağırlık kg/18 pcs	Kutu Adedi / Box Qty.	Birim Fiyat Price (Adet/pcs)
İRTU-POLM1013	1NMD-1	3	20	6,00	9,00	18	363,90 TL

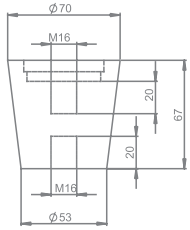

Çift Taraf Kör Somunlu / Two Sided Blind Standoff Insulators

Kod / Code	Tip / Type	Kullanım Voltajı ~ kV	Test Voltajı ~ kV	Gerilim Direnci kN	Ağırlık kg/18 pcs	Kutu Adedi / Box Qty.	Birim Fiyat Price (Adet/pcs)
İRTU-POLM1014	1NMA-2	3	15	5,50	6,65	18	303,25 TL

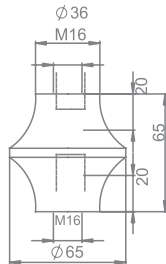

Çift Taraf Kör Somunlu / Two Sided Blind Standoff Insulators

Kod / Code	Tip / Type	Kullanım Voltajı ~ kV	Test Voltajı ~ kV	Gerilim Direnci kN	Ağırlık kg/18 pcs	Kutu Adedi / Box Qty.	Birim Fiyat Price (Adet/pcs)
İRTU-POLM1015	1NMC-3	3	15	5,00	4,60	18	326,25 TL

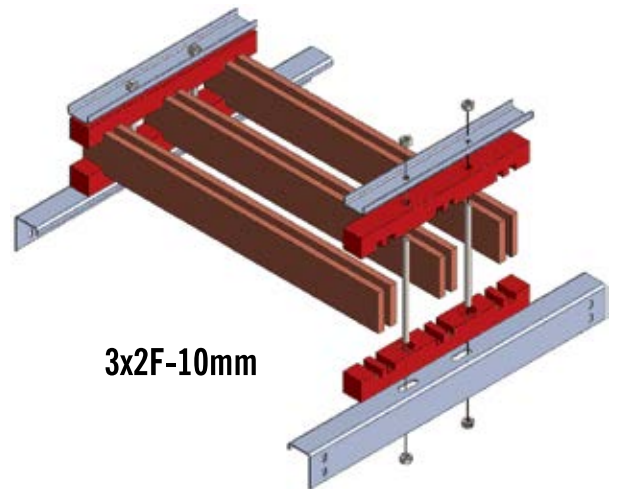
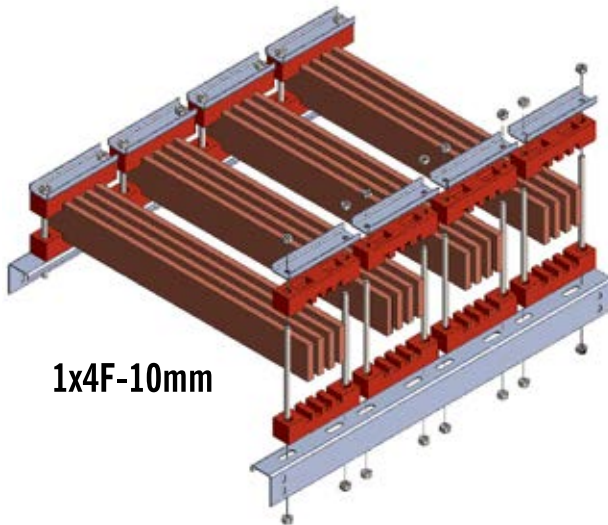
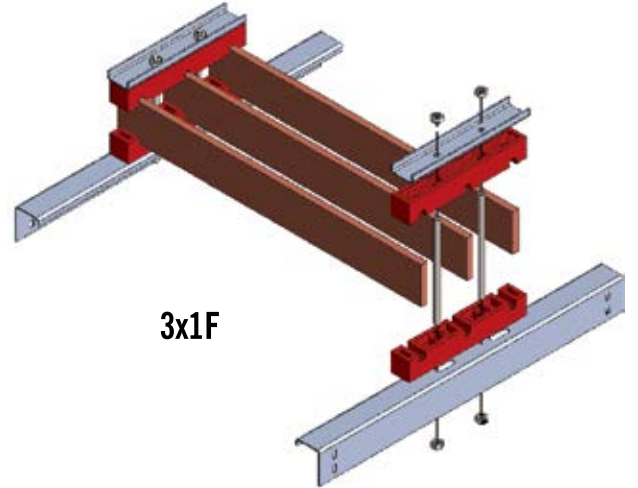
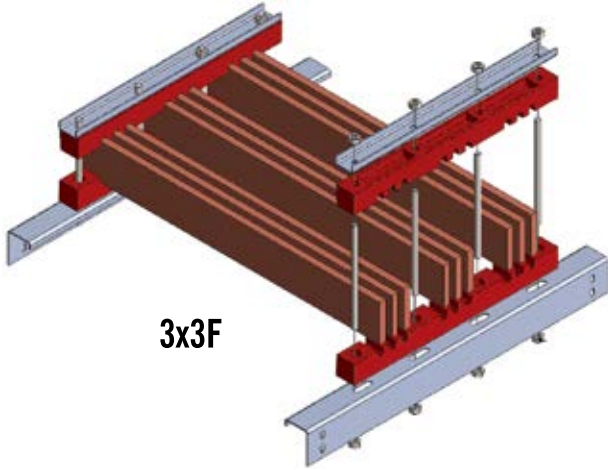
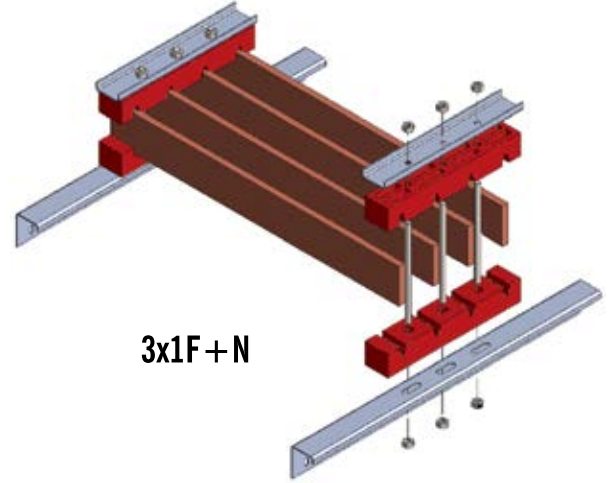
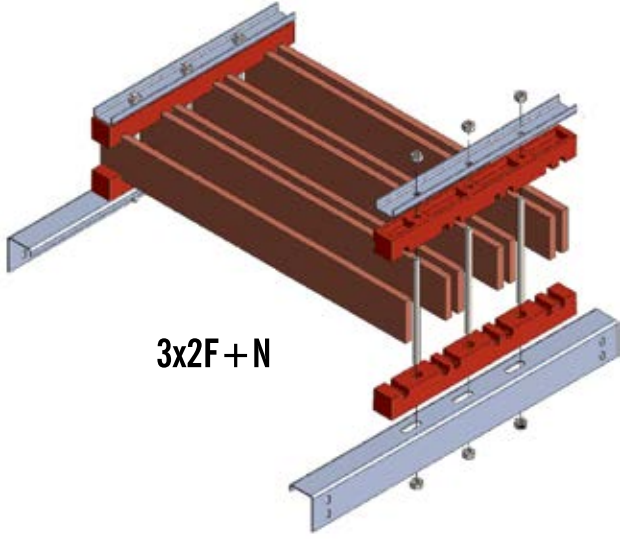

3x1F Tarak İzolatör / 3x1F Busbar Busbar Support Insulator



Kod / Code	Tip / Type	Ölçüler / Dimensions (mm)									Min. Strength kN	Kutu Adedi / Box Qty	Birim Fiyat Unit Price (Adet/pcs)
		A	B	C	D	E1	E2	F1	F2	H			
İRTU-POLT1002	3x1F/5-10 mm	74,5	74,5	73	193	30	30	10,5	5,5	Ø11	5	40	148,20 TL

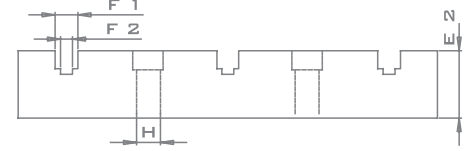
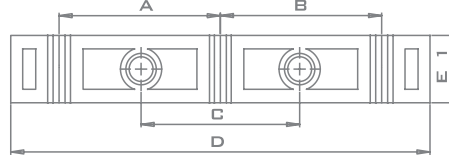

3x1F Tarak İzolatör / 3x1F Busbar Support Insulator



Kod / Code	Tip / Type	Ölçüler / Dimensions (mm)									Min. Strength kN	Kutu Adedi / Box Qty	Birim Fiyat Unit Price (Adet/pcs)
		A	B	C	D	E1	E2	F1	F2	H			
İRTU-POLT1012	3x1F/5-10 mm	74	74	74	193	30	30	6	11	Ø9,5	5	40	92,80 TL

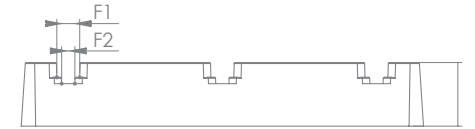
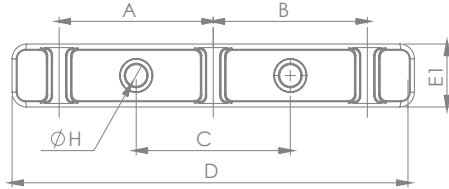

3x1F+N Tarak İzolatör / 3x1F+N Busbar Support Insulator



Kod / Code	Tip / Type	Ölçüler / Dimensions (mm)									Min. Strength kN	Kutu Adedi / Box Qty	Birim Fiyat Unit Price (Adet/pcs)
		A	C	D	E1	E2	F1	F2	H				
İRTU-POLT1013	3x1F+N/5-10 mm	74	74	269	30	28	11	6	Ø9,5	5	50	117,80 TL	

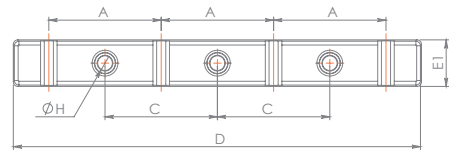

3x1F+N Tarak İzolator / 3x1F+N Busbar Support Insulator



Kod / Code	Tip / Type	Ölçüler / Dimensions (mm)								Min. Strength kN	Kutu Adedi / Box Qty	Birim Fiyat Unit Price (Adet/pcs)
		A	C	D	E1	E2	F1	F2	H			
İRTU-POLT1005	3x1F+N/5-10 mm	60	60	230	40	34,5	10,5	5,5	Ø9	5	32	160,85 TL

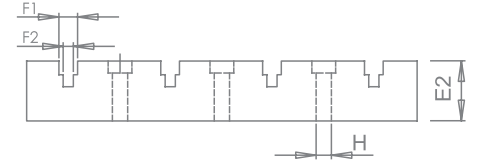
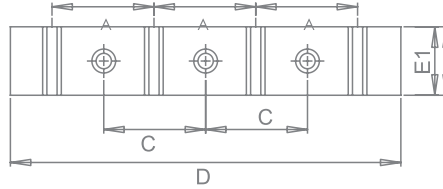

3x2F Tarak İzolator / 3x2F Busbar Support Insulators



Kod / Code	Tip / Type	Ölçüler / Dimensions (mm)								Min. Strength kN	Kutu Adedi / Box Qty	Birim Fiyat Unit Price (Adet/pcs)
		A	B	C	D	E1	E2	F1	H			
İRTU-POLT1007	3x2F/10 mm	82	82	105	285	31	30	10,5	Ø11	5	50	180,40 TL
İRTU-POLT1008	3x2F/5 mm	91,5	91,5	105	285	31	30	5,5	Ø11	5	50	180,40 TL

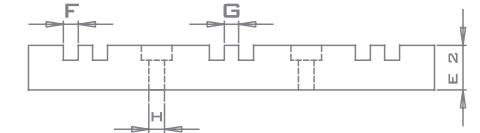
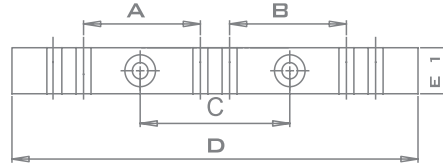

3x2F Tarak İzolator / 3x2F Busbar Support Insulator

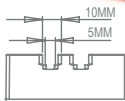

Kod / Code	Tip / Type	Ölçüler / Dimensions (mm)								Min. Strength kN	Kutu Adedi / Box Qty	Birim Fiyat Unit Price (Adet/pcs)	
		A	B	C	D	E1	E2	F1	F2				H
İRTU-POLT1015	3x2F/5-10 mm	82	82	105	285	31	30	10,5	5,5	Ø11	5	50	144,35 TL

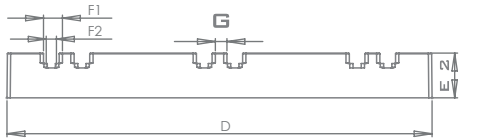
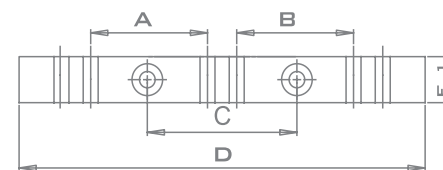

3x2F+N Tarak İzolator / 3x2F+N Busbar Support Insulator



Kod / Code	Tip / Type	Ölçüler / Dimensions (mm)										Min. Strength kN	Kutu Adedi / Box Qty	Birim Fiyat Unit Price (Adet/pcs)
		A1	A2	C	D	E1	E2	F1/F2	G	H				
İRTU-POLT1009	3x2F+N/5-10 mm	20,5	65	85,5	303	31	30	10,5/5,5	54,5	Ø8,5	5	50	311,60 TL	

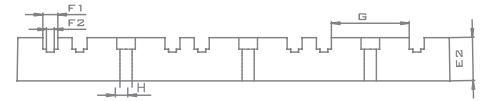
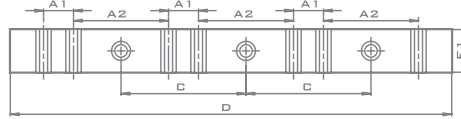

3x3F Tarak İzolator / 3x3F Busbar Support Insulator



Kod / Code	Tip / Type	Ölçüler / Dimensions (mm)										Min. Strength kN	Kutu Adedi / Box Qty	Birim Fiyat Unit Price (Adet/pcs)	
		A1	A2	C1	C2	D	E1	E2	F1	F2	G				H
İRTU-POLT1010	3x3F/5-10 mm	20,5	65	98,75	106	340	30	30	10,5	5,5	10	Ø8,5	5	20	358,00 TL

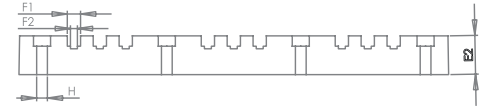
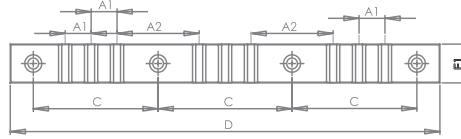

1x4F Tarak İzolator / 1x4F Busbar Support Insulator



Kod / Code	Tip / Type	Ölçüler / Dimensions (mm)								Min. Direnç kN	Kutu Adedi / Box Qty	Birim Fiyat Unit Price (Adet/pcs)
		A	C	D	E1	E2	F1	F2	H			
İRTU-POLT1004	1x4F/5 mm	22	110	134	31	29	5,5	10,5	Ø9	5	50	87,65 TL
İRTU-POLT1001	1x4F/10 mm	22	110	134	31	29	10,5	10,5	Ø9	5	50	87,65 TL

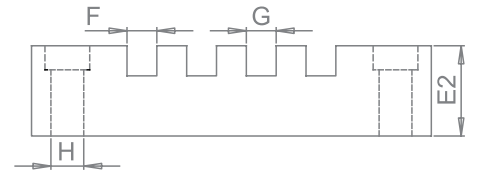
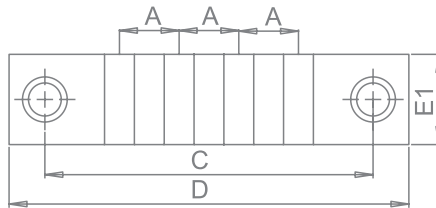

3x1FK Tarak İzolator / 3x1FK Busbar Support Insulator



Kod / Code	Tip / Type	Ölçüler / Dimensions (mm)								Min. Direnç kN	Kutu Adedi / Box Qty	Birim Fiyat Unit Price (Adet/pcs)
		A	C	D	E1	E2	F	G	H			
İRTU-POLT1003	3x1FK/5 mm Bakır	33	110	134	31	29	5,5	27	Ø9	5	50	92,20 TL

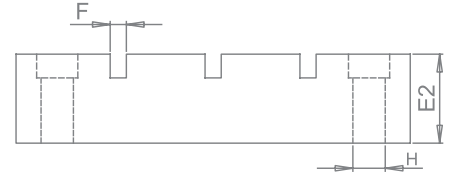
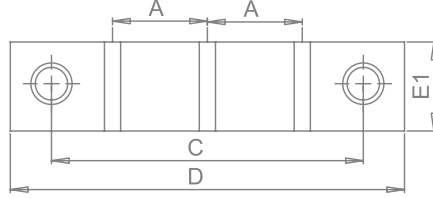

3x1FY+N Tarak İzolator / 3x1FY+N Busbar Support Insulator



Kod / Code	Tip / Type	Ölçüler / Dimensions (mm)								Min. Direnç kN	Kutu Adedi / Box Qty	Birim Fiyat Unit Price (Adet/pcs)
		A	B	C	D	E1	E2	F	H			
İRTU-POLT1006	3x1FY + N	25	10	125	150	38	40	20	Ø6	5	26	188,30 TL

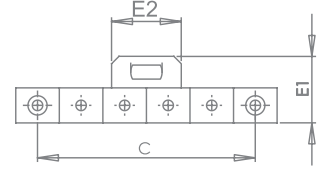
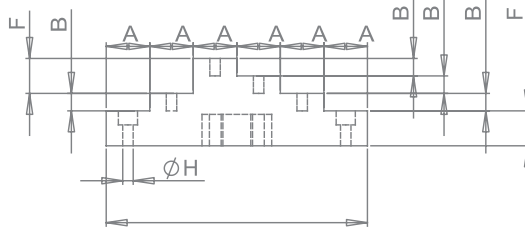

Bara İzolatörü / Busbar Insulator

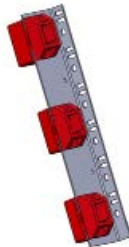

Kod / Code	Tip / Type	Kullanım Voltajı ~ kV	Test Voltajı ~ kV	Gerilim Direnci kN	Ağırlık gr / pcs	Kutu Adedi / Box Qty.	Birim Fiyat Price (Adet/pcs)
İRTU-POLM203858	H:20mm	3	15	5,00	0.150	50	324,00 TL
İRTU-POLM303858	H:30mm	3	15	5,00	0.175	50	348,00 TL

- Dikeyde veya yatayda bakırları taşımak için kullanılır.
/ Product Used for carrying copper busbars vertically and horizontally.
- İzolatörler, bağlantı mesafelerine göre birbirinden bağımsız uygulanabilir.
/ Insulators can be applied independently according to connection span length and mounted to the main chassis with the sheet metal part.
- İzolatörler ana şaseye sac parça ile monte edilir.
/ Insulators are mounted onto the main chassis with a metal sheet part.



PLASTİK (V0) İZOLATÖRLER

Alçak gerilim plastik izolatörleri alev almaz (V0) malzemedendir. BMC izolatörlerle aynı amaç için kullanılır. Düşük kırılma oranı nedeniyle BMC izolatörlere göre daha esneklerdir.

PLASTİK (V0) İZOLATÖRLER



Yanmaz (V0) malzemeden imal edilmiştir. Polyester izolatörler ile aynı amaç için kullanılır, BMC malzemeye göre daha esnek olmasından dolayı kırılma oranı düşüktür. Kimyasal özellikleri aşağıdaki gibidir;

- Cam elyaf takviyeli yanmaz plastik (PA6), %30 elyaf ihtiva eder.
- Standart renk: Siyah
- Körsomunlar: Çelik çinko kaplamalı (istek üzerine pirinç malzeme)
- Civata: cr3 8.8 çelik civata

Low tension post insulators is made of non-flammable (V0) material. It is used for the same purpose as BMC insulators. It is more flexible than BMC insulators due to refraction rate is low. It's chemical characters are listed below:

- Fiber Glass reinforced poliamid (PA6) nonflamable, has 30% of fibers.
- Standart color: Black
- Nuts: Steel-zinc line. (Brass material can used if needed)
- Bolts: Cr3 8.8 steel bolt

Uygun Çalışma Sıcaklığı <i>Application</i>	Genel elektroteknik uygulaması Sıcaklık aralığı	<i>General electrotechnical application.</i> <i>Temperature range</i>	-40 °C to +130 °C	
Fiziksel Özellikler <i>Pyhsical Properties</i>	Cam elyaf oranı Özkütle Kalıp çekmesi Su emme	<i>Glassfibre Contents</i> <i>Specific Weight</i> <i>Moulding Shrinkage</i> <i>Water Absorption</i>	30% 1,56g/cm ³ <0,03% <0,2% (<25mg)	DIN EN ISO 62
Mekanik Özellikler <i>Mechanical Properties</i>	Martens derecesi Bükülme dayanıklılığı Darbe dayanıklılığı	<i>Martens Degree</i> <i>Flexural Strength</i> <i>Impact Strength</i>	>200°C 205 N/mm ² 14 kJ/m ²	DIN 53462 DIN EN ISO 178 DIN EN ISO 180
Elektriksel Özellikler <i>Electrical Properties</i>	Yüzel direnci Elektrik öz direnci Dielectric dayanımı Alev alma dayanımı	<i>Surface Resistivity</i> <i>Volume Resistivity</i> <i>Dielectric Strength</i> <i>Tracking Resistance</i>	10 ¹⁴ Ωcm 10 ¹⁴ Ωcm 150 kV/cm CTI 600	DIN IEC 60093 DIN IEC 60093 DIN EN 60243-1 DIN IEC 60112
Yanmazlık <i>Flammability</i>	Kızaran tel testi	<i>Glow -wire Flammability</i>	960° C	DIN EN 60695

Çift Taraf Kör Somunlu SW30 / H30 / Two Sided Blind Standoff Insulators SW30/H30

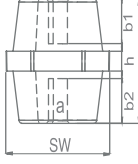

Kod / Code	Tip / Type	Ölçüler / Dimensions (mm)					Kullanım Voltajı ~ kV	Test Voltajı ~ kV	Gerilim Direnci kN	Ağırlık kg/box	Kutu Adedi / Box Qty.	Birim Fiyat Price (Adet/pcs)
		a1	b1	b2	SW	h						
İRTU-PLSM303006	M6	6	11	11	30	30	1	3	4	6	100	132,00 TL
İRTU-PLSM303008	M8	8	11	11	30	30	1	3	4	6,20	100	137,50 TL
İRTU-PLSM303010	M10	10	11	11	30	30	1	3	4	6,50	100	139,70 TL

Çift Taraf Kör Somunlu SW32 / H35 / Two Sided Blind Standoff Insulators SW32/H35

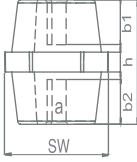

Code	Tip / Type	Ölçüler / Dimensions (mm)					Kullanım Voltajı ~ kV	Test Voltajı ~ kV	Gerilim Direnci kN	Ağırlık kg/box	Kutu Adedi / Box Qty.	Birim Fiyat Price (Adet/pcs)
		a1	b1	b2	SW	h						
İRTU-PLSM323506	M6	6	11	11	32	35	1	3	4	6,70	100	
İRTU-PLSM323508	M8	8	11	11	32	35	1	3	4	6,90	100	
İRTU-PLSM323510	M10	10	11	11	32	35	1	3	4	7,20	100	

Çift Taraf Kör Somunlu SW40 / H40 / Two Sided Blind Standoff Insulators SW40/H40

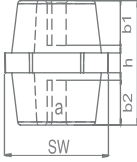

Code	Tip / Type	Ölçüler / Dimensions (mm)					Kullanım Voltajı ~ kV	Test Voltajı ~ kV	Gerilim Direnci kN	Ağırlık kg/box	Kutu Adedi / Box Qty.	Birim Fiyat Price (Adet/pcs)
		a1	b1	b2	SW	h						
İRTU-PLSM404006	M6	6	11	11	40	40	1	3	4	6,70	100	
İRTU-PLSM404008	M8	8	11	11	40	40	1	3	4	6,90	100	
İRTU-PLSM404010	M10	10	11	11	40	40	1	3	4	7,20	100	

Çift Taraf Kör Somunlu 1N500 / Two Sided Blind Standoff Insulators 1N500

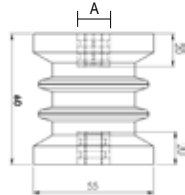

Kod / Code	Tip / Type	Somun Ölçüsü Nut Measure (A)	Kullanım Voltajı ~ kV	Test Voltajı ~ kV	Gerilim Direnci kN	Ağırlık kg/18 pcs	Kutu Adedi / Box Qty.	Birim Fiyat Price (Adet/pcs)
İRTU-PLSM1020	1N500	M8	3	15	5,00	7,00	32	225,00 TL
İRTU-PLSM1021	1N500	M10	3	15	5,00	7,00	32	235,00 TL
İRTU-PLSM1022	1N500	M12	3	15	5,00	7,00	32	245,00 TL

3x1F (10mm) - 3x1F (5mm) Tarak İzolatör (4 TİJ) / 3x1F (10mm) - 3x1F (5mm) Busbar Support Insulator (4 TIJ)

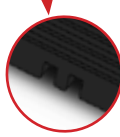
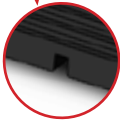
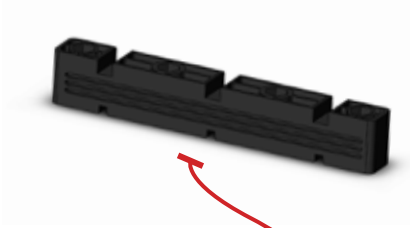

Kod / Code	Tip / Type	Ölçüler / Dimensions (mm)									Min. Direnç kN	Kutu Adedi / Box Qty	Birim Fiyat Unit Price (Adet/pcs)
		A	C1	C2	D	E1	E2	F1	F2	H			
İRTU-PLST1015	3x1F / 5-10mm	74	74	58,14	220	25	35	10,5	5,5	Ø8,5	5	50	199,90 TL

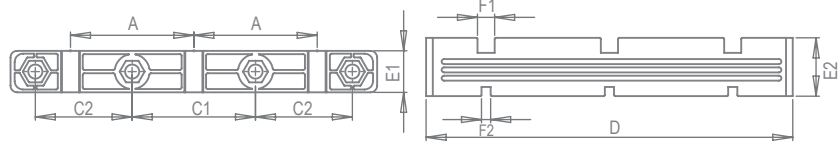

3x1F (10mm) - 3x1F (2x5mm) Tarak İzolatör (4 TİJ)

Kod / Code	Tip / Type	Ölçüler / Dimensions (mm)									Min. Direnç kN	Kutu Adedi / Box Qty	Birim Fiyat Unit Price (Adet/pcs)
		A	C1	C2	D	E1	E2	F1	F2	H			
İRTU-PLST1023	3x1F / 5-10mm	74	74	58,14	220	25	35	10,5	5,5	Ø8,5	5	50	266,00 TL

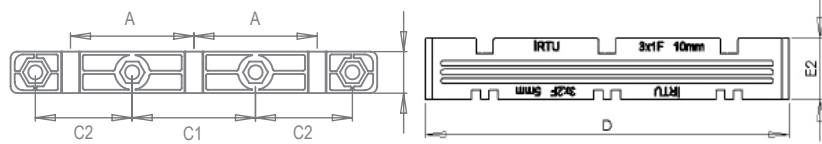

3x1F Tarak İzolatör / 3x1F Busbar Support Insulator



Kod / Code	Tip / Type	Ölçüler / Dimensions (mm)								Min. Direnç kN	Kutu Adedi / Box Qty	Birim Fiyat Unit Price (Adet/pcs)
		A	C	D	E1	E2	F1	F2	H			
İRTU-PLST1001	3x1F / 5-10mm	74	73	196	25	34,5	10,5	5,5	Ø8,5	5	50	187,00 TL

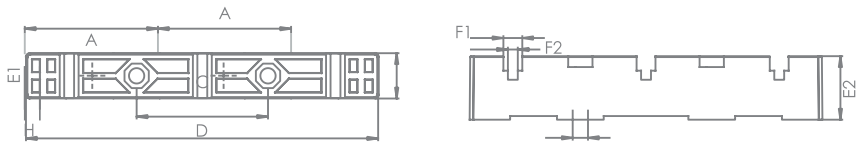

3x1F Tarak İzolatör (Eko) / 3x1F Busbar Support Insulator (Eco)



Kod / Code	Tip / Type	Ölçüler / Dimensions (mm)								Min. Direnç kN	Kutu Adedi / Box Qty	Birim Fiyat Unit Price (Adet/pcs)
		A	C	D	E1	E2	F1	F2	H			
İRTU-PLST1000	3x1F / 5-10mm	74	73	196	25	34,5	10,5	5,5	Ø8,5	5	50	138,15 TL

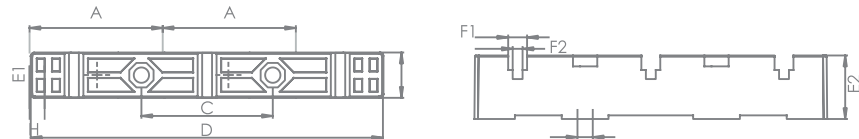

3x1F+N (5-10mm) Tarak İzolatör / 3x1F+N (5-10mm) Busbar Support Insulator



Kod / Code	Tip / Type	Ölçüler / Dimensions (mm)								Min. Direnç kN	Kutu Adedi / Box Qty	Birim Fiyat Unit Price (Adet/pcs)
		A	C	D	E1	E2	F1	F2	H			
İRTU-PLST1003	3x1F+N/5-10mm	65	65	240	25,5	35,0	10,5	5,5	Ø9	5	50	224,15 TL

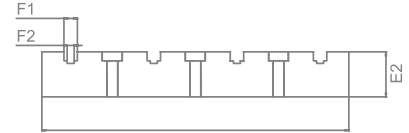
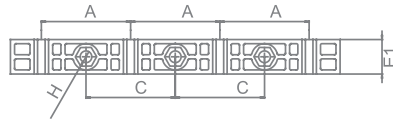

4x1F (10mm) - 4x2F (5mm) Tarak İzolatör / 4x1F (10mm) - 4x2F (5mm) Busbar Support Insulator



Kod / Code	Tip / Type	Ölçüler / Dimensions (mm)										Min. Direnç kN	Kutu Adedi / Box Qty	Birim Fiyat Unit Price (Adet/pcs)
		A	A1	A2	A3	B	C	D	E	F	L			
İRTU-PLST1021	4x1F - 10 mm	10,5	54	65		64,5	61,5	8,5	25	35	285	5	50	283,20 TL
	4x2F -5mm	5,5	48,5	48,5	16	64,5	61,5	8,5	25	35	285			

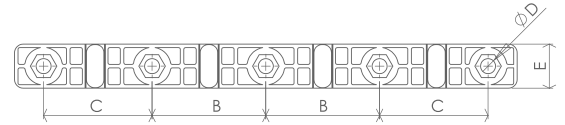
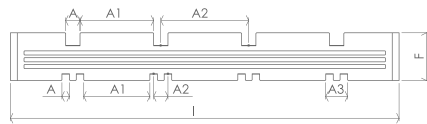

4x2F (5-10 mm) Tarak İzolatör / 4x2F (5-10 mm) Busbar Support Insulator



Kod / Code	Tip / Type	Ölçüler / Dimensions (mm)									Min. Direnç kN	Kutu Adedi / Box Qty	Birim Fiyat Unit Price (Adet/pcs)	
		A1	A2	C1	C2	D	E1	E2	F1	F2				H
İRTU-PLST1016	4x2F / 10 mm. 4x2F / 5 mm.	31	64	95	95	340	25,0	35	10,5	5,5	Ø8,5	5	50	354,75 TL

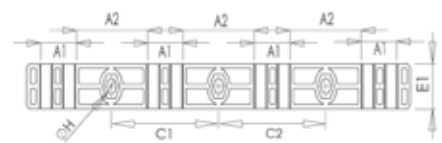
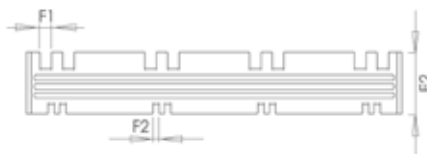

3x2F (10mm) Tarak İzolatör / 3x2F (10mm) Busbar Support Insulator



Kod / Code	Tip / Type	Ölçüler / Dimensions (mm)									Min. Direnç kN	Kutu Adedi / Box Qty	Birim Fiyat Unit Price (Adet/pcs)
		A1	A2	C1	C2	D	E1	E2	F	H			
İRTU-PLST1002	3x2F / 10 mm.	20,5	81,3	80	105	290	25,0	34,5	10,5	Ø8,5	5	50	324,40 TL

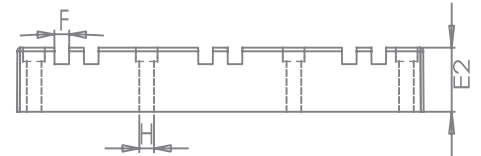
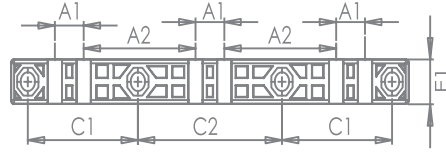

3x2F (10mm) - 3x4F (5mm) Tarak İzolatör / 3x2F (10mm) - 3x4F (5mm) Busbar Support Insulator



Kod / Code	Tip / Type	Ölçüler / Dimensions (mm)											Min. Direnç kN	Kutu Adedi / Box Qty	Birim Fiyat Unit Price (Adet/pcs)
		A	A1	A2	A3	A4	B	C	D	E	F	L			
İRTU-PLST1022	3x2F - 10 mm.	10,5	84,5	20,5	74	31	106	87,5	8,5	30	35	305	5	50	305,50 TL
	3x4F - 5 mm.	5,5	73,5	10,5	68	37	106	87,5	8,5	30	35	305			

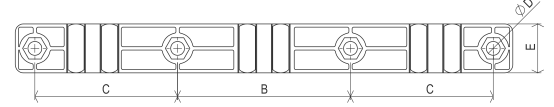
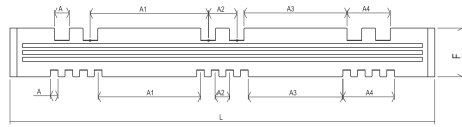

3x3F (10mm) - 3x4F (5mm) Tarak İzolatör / 3x3F (10mm) - 3x4F (5mm) Busbar Support Insulator



Kod / Code	Tip / Type	Ölçüler / Dimensions (mm)											Min. Direnç kN	Kutu Adedi / Box Qty	Birim Fiyat Unit Price (Adet/pcs)
		A	A1	A2	A3	A4	B	C	D	E	F	L			
İRTU-PLST1024	3x3F - 10 mm.	10,5	74	20,5	125,5	51,5	125,5	109,5	8,5	30	35	380	5	50	445,00 TL
	3x5F - 5 mm.	5,5	78	10,5	125,5	47,5	125,5	109,5	8,5	30	35	380	5	50	

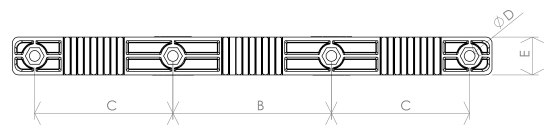
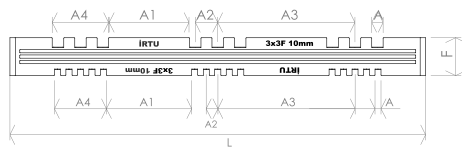

1x4F (10 mm) Tarak İzolator (Altı Düz Tip) / 1x4F (10 mm) Busbar Support Insulator



Kod / Code	Tip / Type	Ölçüler / Dimensions (mm)							Min. Direnç kN	Kutu Adedi / Box Qty	Birim Fiyat Unit Price (Adet/pcs)
		A	C	D	E1	E2	F1	F2			
İRTU-PLST1009	1x4F / 10mm	20,5	115	10,5	100	35	35	10	5	80	197,65 TL

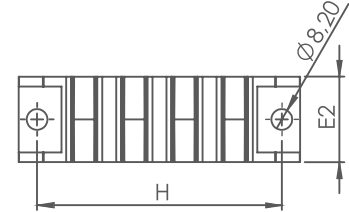
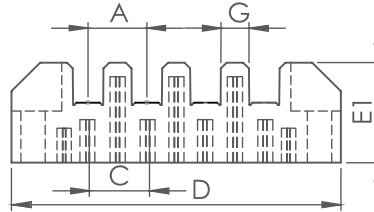

1x4F (10 mm) Tarak İzolator / 1x4F (10 mm) Busbar Support Insulator



Kod / Code	Tip / Type	Ölçüler / Dimensions (mm)									Min. Direnç kN	Kutu Adedi / Box Qty	Birim Fiyat Unit Price (Adet/pcs)
		A	C	C1	D	F	I	E1	E2	G			
İRTU-PLST1006	1x4F/10 mm.	20,5	20,0	8,4x8,4	115	105	100	35	35	10	5	100	170,80 TL

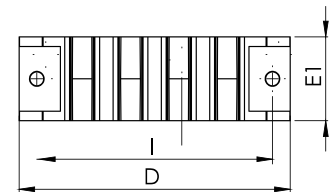
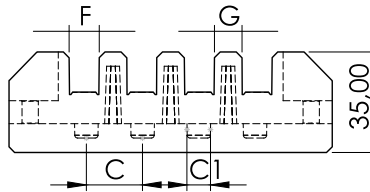

Kod / Code	Tip / Type	Kullanılan İzolator Adedi/ Number of Insulators Used	Kullanılan Saç Profil Uzunluğu/ The Length of the Sheet Profile Used	Kutu Adedi / Box Qty	Birim Fiyat Unit Price (Adet/pcs)
İRTU-PLST1306	1x4F/10 mm 3 Faz Takım 3 Phase Close Set	6	575 mm	1	4.475,00 TL
İRTU-PLST1406	1x4F/10 mm 3 Faz+N Takım 3 Phase+N Close Set	8	675 mm	1	5.369,20 TL



1x4F (5 mm) Tarak İzolatör / 1x4F (5 mm) Busbar Support Insulator



Kod / Code	Tip / Type	Ölçüler / Dimensions (mm)									Min. Direnç kN	Kutu Adedi / Box Qty	Birim Fiyat Unit Price (Adet/pcs)
		A	C	C1	D	I	F	E1	E2	G			
İRTU-PLST1020	1x4F/5 mm.	15,5	25	8X12,4	90	75	5,5	30	37	10	5	100	124,05 TL

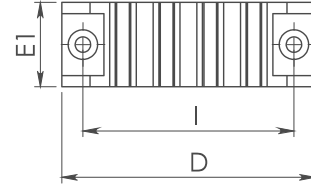
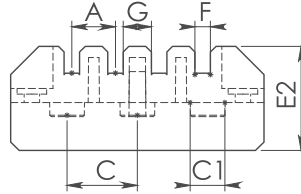

Kod / Code	Tip / Type	Kullanılan İzolatör Adedi/ Number of Insulators Used	Kullanılan Saç Profil Uzunluğu/ The Length of the Sheet Profile Used	Kutu Adedi / Box Qty	Birim Fiyat Unit Price (Adet/pcs)
İRTU-PLST1320	1x4F/5 mm 3 Faz Takım	6	575 mm	1	4.088,00 TL
İRTU-PLST1420	1x4F/5 mm 3 Faz+N Takım	8	675 mm	1	4.792,00 TL

1x4F (5 mm) Tarak İzolatör / 1x4F (5 mm) Busbar Support Insulator



Kod / Code	Tip / Type	Ölçüler / Dimensions (mm)							Min. Direnç kN	Kutu Adedi / Box Qty	Birim Fiyat Unit Price (Adet/pcs)	
		A	C	C1	D	F1	E1	E2				G
İRTU-PLST1005	1x4F/5 mm.	10,5	20,0	8	65,0	5,5	35,5	30	5,0	5	100	108,95 TL

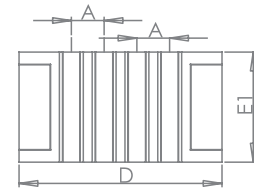
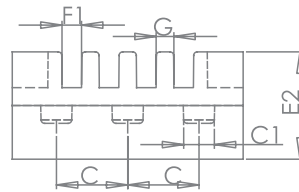

Kod / Code	Tip / Type	Kullanılan İzolatör Adedi/ Number of Insulators Used	Kullanılan Saç Profil Uzunluğu/ The Length of the Sheet Profile Used	Kutu Adedi / Box Qty	Birim Fiyat Unit Price (Adet/pcs)
İRTU-PLST1305	1x4F/5 mm 3 Faz Takım	6	430 mm	1	3.510,00 TL
İRTU-PLST1405	1x4F/5 mm 3 Faz+N Takım	8	600 mm	1	4.320,00 TL

1x3F (10 mm) Tarak İzolatör / 1x3F (10mm) Busbar Support Insulator



Kod / Code	Tip / Type	Ölçüler / Dimensions (mm)										Min. Direnç kN	Kutu Adedi / Box Qty	Birim Fiyat Unit Price (Adet/pcs)
		A	C	C1	D	F	H	I	E1	E2	G			
İRTU-PLST1008	1x3F / 10 mm.	20,5	25	8x12,4	90	10,5	12	10,5	30	37	Ø10	5	100	124,05 TL
İRTU-PLST1018	1x3F / 10 mm.	20,5	25	8x12,4	90	10,5	9,5	75	30	37	Ø10	5	100	124,05 TL

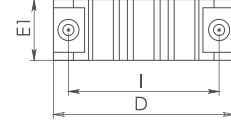
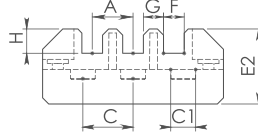

Kod / Code	Tip / Type	Kullanılan İzolatör Adedi/ Number of Insulators Used	Kullanılan Saç Profil Uzunluğu/ The Length of the Sheet Profile Used	Kutu Adedi / Box Qty	Birim Fiyat Unit Price (Adet/pcs)
İRTU-PLST1308	1x3F/10 mm 3 Faz Takım 3 Phase Close Set	6	575 mm	1	4.029,00 TL
İRTU-PLST1408	1x3F/10 mm 3 Faz+N Takım 3 Phase+N Close Set	8	675 mm	1	4.792,50 TL

1x3F (5 mm) Tarak İzolatör / 1x3F (5 mm) Busbar Support Insulator



Kod / Code	Tip / Type	Ölçüler / Dimensions (mm)										Min. Direnç kN	Kutu Adedi / Box Qty	Birim Fiyat Unit Price (Adet/pcs)
		A	C	C1	D	F	I	E1	E2	G				
İRTU-PLST1011	1x3F/5 mm.	10,5	25,0	8x12,4	65,0	5,5	50,0	30,0	37,0	5,0	5	100	102,95 TL	

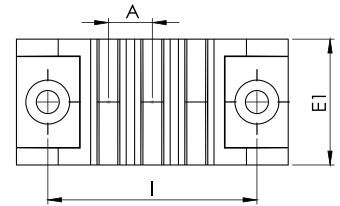
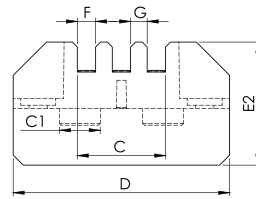

Kod / Code	Tip / Type	Kullanılan İzolatör Adedi/ Number of Insulators Used	Kullanılan Saç Profil Uzunluğu/ The Length of the Sheet Profile Used	Kutu Adedi / Box Qty	Birim Fiyat Unit Price (Adet/pcs)
İRTU-PLST1311	1x3F/5 mm 3 Faz Takım	6	430 mm	1	3.510,00 TL
İRTU-PLST1411	1x3F/5 mm 3 Faz+N Takım	8	600 mm	1	4.320,00 TL

1x3F (10 mm) Tarak İzolatör / 1x3F (10 mm) Busbar Support Insulator



Kod / Code	Tip / Type	Ölçüler / Dimensions (mm)											Min. Direnç kN	Kutu Adedi / Box Qty	Birim Fiyat Unit Price (Adet/pcs)
		A	D	F	I	E1	E2	G	C	C1	N	M			
İRTU-PLST1010	1x3F/10 mm.	21	69,6	10,5	51,5	55	25	10	63	35,5	3,35	15,7	5	100	104,50 TL

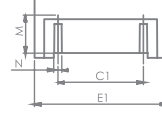
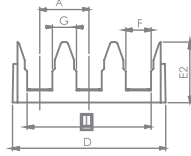

Kod / Code	Tip / Type	Kullanılan İzolatör Adedi/ Number of Insulators Used	Kullanılan Saç Profil Uzunluğu/ The Length of the Sheet Profile Used	Kutu Adedi / Box Qty	Birim Fiyat Unit Price (Adet/pcs)
İRTU-PLST1310	1x3F/10 mm 3 Faz Takım 3 Phase Close Set	6	575 mm	1	3.900,00 TL
İRTU-PLST1410	1x3F/10 mm 3 Faz+N Takım 3 Phase+N Close Set	8	675 mm	1	4.500,00 TL

1x2F (10 mm) Tarak İzolatör / 1x2F (10 mm) Busbar Support Insulator



Kod / Code	Tip / Type	Ölçüler / Dimensions (mm)										Min. Direnç kN	Kutu Adedi / Box Qty	Birim Fiyat Unit Price (Adet/pcs)
		A	C	C1	D	F	H	I	E1	E2	G			
İRTU-PLST1007	1x2F / 10 mm.	20,5	25	8x12,4	65	10,5	12	50	30	37	Ø10	5	100	102,95 TL
İRTU-PLST1017	1x2F / 10 mm.	20,5	25	8x12,4	65	10,5	9,5	50	30	33	Ø10	5	100	102,95 TL

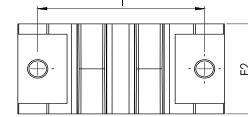
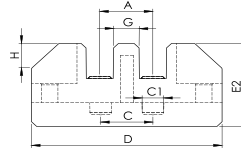

Kod / Code	Tip / Type	Kullanılan İzolatör Adedi/ Number of Insulators Used	Kullanılan Saç Profil Uzunluğu/ The Length of the Sheet Profile Used	Kutu Adedi / Box Qty	Birim Fiyat Unit Price (Adet/pcs)
İRTU-PLST1307	1x2F/10 mm 3 Faz Takım 3 Phase Close Set	6	430 mm	1	3.510,00 TL
İRTU-PLST1407	1x2F/10 mm 3 Faz+N Takım 3 Phase+N Close Set	8	600 mm	1	4.320,00 TL

1x2F - 1x3F (5-10mm) Tarak İzolatör / 1x2F - 1x3F (5-10 mm) Busbar Support Insulator



Kod / Code	Tip / Type	Ölçüler / Dimensions (mm)					Min. Direnç kN	Kutu Adedi/ Box Qty	Birim Fiyatı Price (adet/pcs)
		A	D	H	E1	E2			
İRTU-PLST1012	1x2F - 1x3F / 5-10mm	20,5	120	100	35	30	5	100	199,80 TL

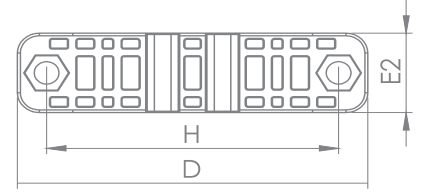
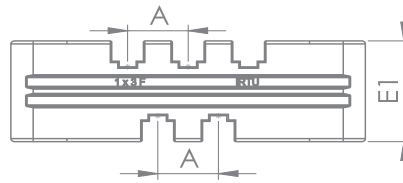

1x6F (5 mm) Tarak İzolatör / 1x6F (5 mm) Busbar Support Insulator

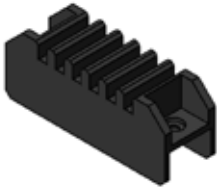

Kod / Code	Tip / Type	Ölçüler / Dimensions (mm)									Min. Direnç kN	Kutu Adedi / Box Qty	Birim Fiyat Unit Price (Adet/pcs)
		A	C	C1	D	F1	I	E1	E2	G			
İRTU-PLST1025	1x6F/5 mm.	10,5	25,0	8x12,4	95	5,5	75	30,0	37,0	5,0	5	100	134,85 TL

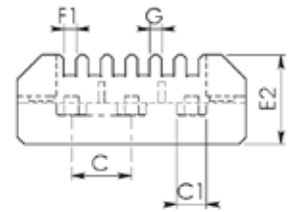
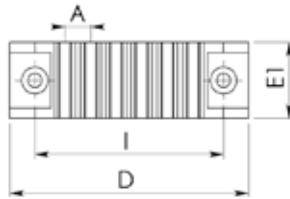

Kod / Code	Tip / Type	Kullanılan İzolatör Adedi/ Number of Insulators Used	Kullanılan Saç Profil Uzunluğu/ The Length of the Sheet Profile Used	Kutu Adedi / Box Qty	Birim Fiyat Unit Price (Adet/pcs)
İRTU-PLST1325	1x6F/5 mm 3 Faz Takım	6	575 mm	1	4.160,00 TL
İRTU-PLST1425	1x6F/5 mm 3 Faz+N Takım	8	675 mm	1	4.864,00 TL



Geçiş İzolatör / Transition Insulator



Kod / Code	Tip / Type	Ölçüler / Dimensions (mm)					Min. Direnç kN	Kutu Adedi / Box Qty	Birim Fiyat Unit Price (Adet/pcs)
		A	B	C	D	E			
IRTU-PLST1013	Geçiş İzolatörü Transition Insulators 20x3/20x4/30x5/30x10	45,0	45,0	35,0	35,0	5,80	5	100	91,00 TL
IRTU-PLST1014	Geçiş İzolatörü Transition Insulators 25x5/20x10/40x10/50x10	60,0	60,0	45,0	45,0	6,50	5	100	118,50 TL

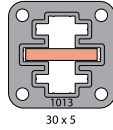
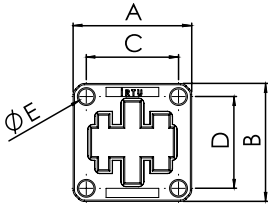

30 x 5

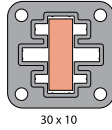

30 x 10

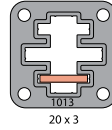

20 x 3

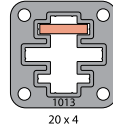

20 x 4

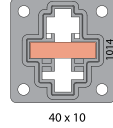

40 x 10

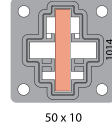

50 x 10

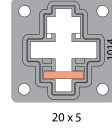

20 x 5

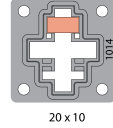

20 x 10

GEÇİŞ İZOLATÖR ÖZELLİKLERİ
BUSHING PROPERTIES

Materyal Material	Cam Takviyeli Polyamid 6.6 Glass Reinforced Polyamid 6.6
Sıcaklık Dayanımı Temperature Resistance	140°C
Yanmazlık Nonflammability	UL94-V0
Voltaj Toleransı Voltage Tolerance	690V
Yanmazlık Insulation Voltage U	690V
Darbe Gerilimi Impulse Voltage U	8 kV
Kızaran Tel Testi Glow Wire	960°C

Kablo Geçiş İzolatör / Cable Transition Insulator

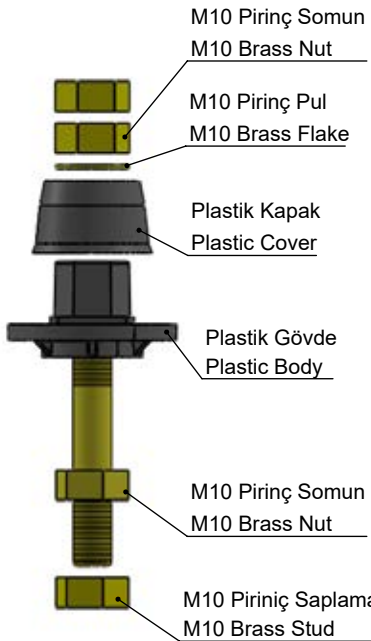

Kod / Code	Tip / Type	Ölçüler / Dimensions (mm)					Kutu Adedi / Box Qty	Birim Fiyat Unit Price (Adet/pcs)
		A	B	C	D	H		
IRTU-PLST5001	Kablo Geçiş İzolatörü Cable Transition Insulators	Ø44,50	Ø31,5	M10	M10	72,50	50	865,50 TL

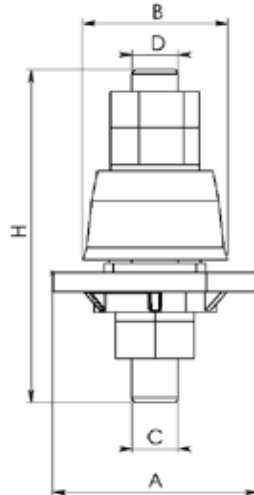

3 Faz Takım Bağlantı Seti
3 Phase Connection Set

3 Faz Takım Bağlantı Şeması
3 Phase Connection Diagram

Ürün Tanımı Product Description	Ürün Resmi Product Image	Adet Piece
İzolatör Insulator		6
Alt Bağlantı Profili Bottom Link Profile		1
Üst Bağlantı Profili Top Link Profile		1
Gijon Gijon		4
Somun Nut		8
Rondela Washer		8

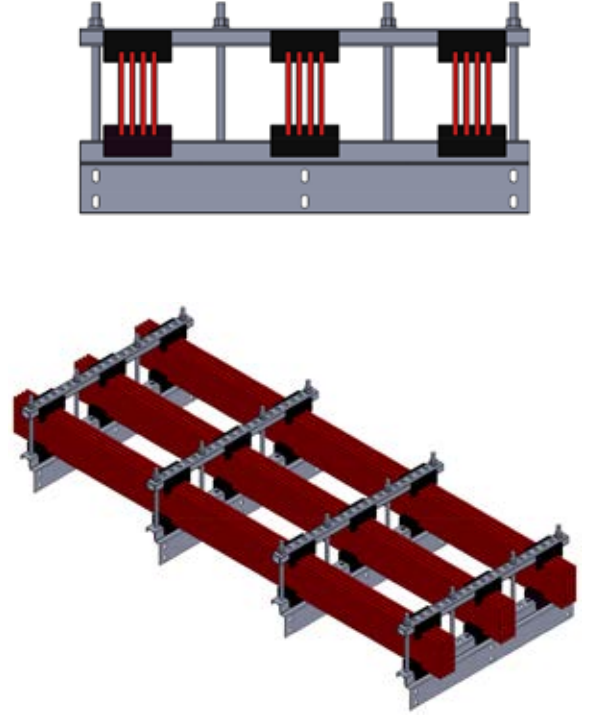

4 Faz Takım Bağlantı Seti
4 Phase Connection Set

4 Faz Takım Bağlantı Şeması
4 Phase Connection Diagram

Ürün Tanımı Product Description	Ürün Resmi Product Image	Adet Piece
İzolatör Insulator		8
Alt Bağlantı Profili Bottom Link Profile		1
Üst Bağlantı Profili Top Link Profile		1
Gijon Gijon		5
Somun Nut		10
Rondela Washer		10

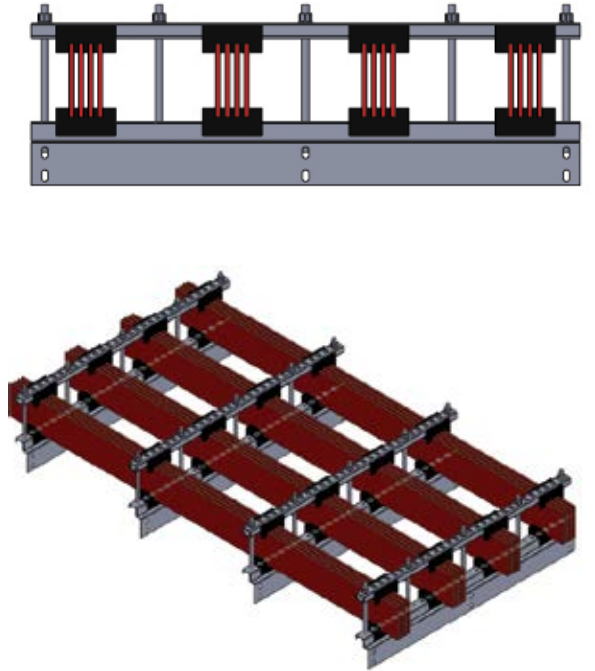

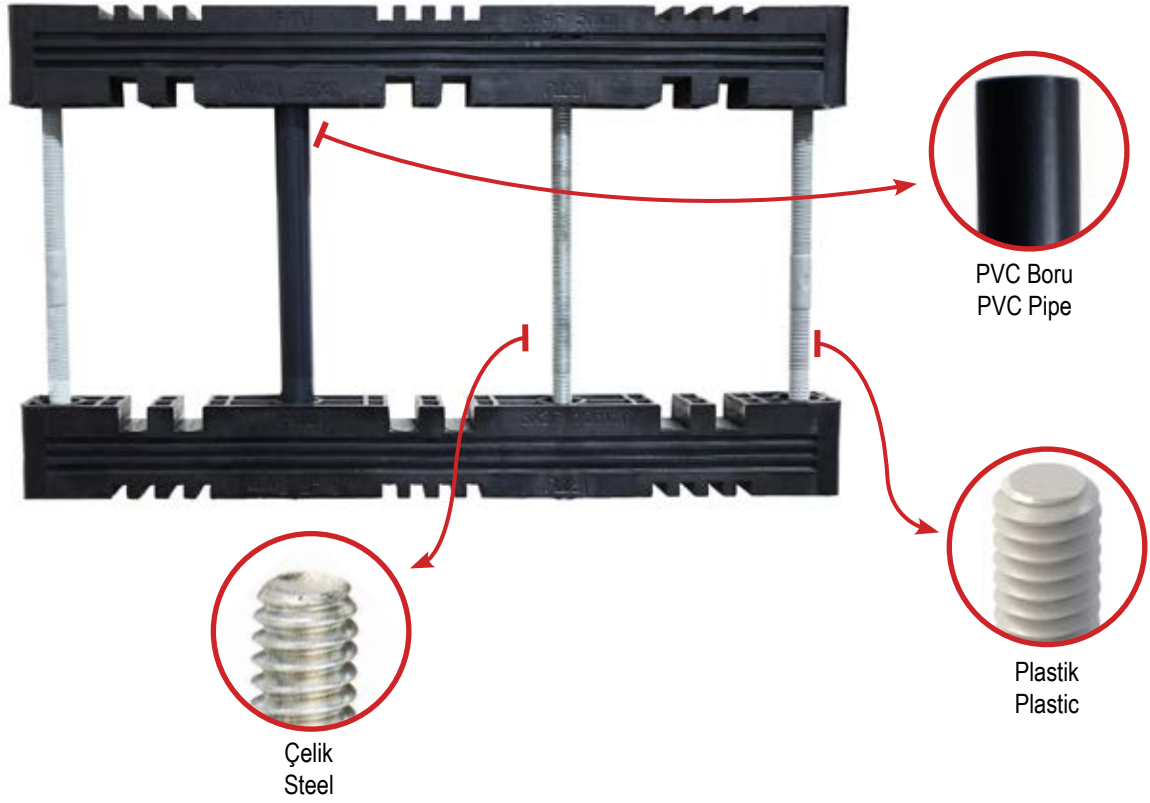

M8 Tij / M8 Threaded Rod



Kod / Code	Tip / Type	A	L	Kutu Adedi / Box Qty	Birim Fiyat Unit Price (Adet/pcs)
İRTU-PTJ2008	M8 Plastik Tij / M8 Plastic Threaded Rod	M8	200mm	100 Ad	68,50 TL
İRTU-CTJ2008	M8 Çelik Tij / M8 Steel Threaded Rod	M8	200mm	100 Ad	
İRTU-CTJ8002	M8 Çelik Tij / M8 Steel Threaded Rod	M8	2mt	100 mt	



PVC İzolasyon Boru / PVC Isolation Pipe



Kod / Code	Tip / Type	A	L	Kutu Adedi / Box Qty	Birim Fiyat Unit Price (mt)
İRTU-PVC4767	PVC İzolasyon Boru Pvc Isolation Pipe	13mm	2mt	50	

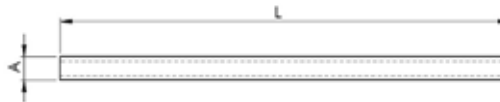

CAM ELYAF (UPGM 203) PLAKALAR

Özellikler / Properties	Testler / Test Method	Birim / Unit
Bükülme dayanıklılığı <i>Flexural strength across</i>	ISO 178	MPa
Bükülme modülü <i>Flexural Modulus</i>	ISO 178 / IEC 60893-2	MPa
İzod darbe dayanıklılığı <i>Izod impact strength paralell to laminations</i>	ISO 180	Kj/m ²
Charpy darbe dayanıklılığı <i>Charpy impact strenght paralell to laminations</i>	ISO 179-1 / ISO 179-2	Kj/m ²
Laminasyona dik 90° yağ içinde elektrik dayanıklılığı <i>Electric strenght at 90° in oil perpendicular to laminations</i>	IEC 60243-1 / IEC 60296	kW/mm
Laminasyona dik 90° yağ içinde bozulma voltajı <i>Electric strenght at 90° in oil perpendicular to laminations</i>	IEC 60243-1 / IEC 60296	kW/mm
Suya batırma sonrası izalasyon dayanımı <i>Insulation resistance after immersion in water</i>	IEC 60167	M

Özellikler / Properties	Testler / Test Method	Birim / Unit
Karşılaştırmalı izleme endeksi <i>Proof tracking index</i>	IEC 60112	CTI
İzleme ve aşında dayanımı <i>Tracking and erosion resistance</i>	IEC 60587	Class
Yanmazlık <i>Flammability</i>	IEC 60695-10-11 IEC 60893-3	UL94
Kızaran tel <i>Glow wire</i>	TS EN 60695-2-13	°C
Su emme <i>Water Absorption</i>	TS EN 60893-2	Mg
Basınç dayanıklılığı <i>Compressive Strength</i>	TS EN ISO 604	N/mm ²
Tüm yüzeye uygulanan basınç dayanıklılığı <i>Pressure strenght along across</i>	ISO 527	N/mm ²

Ürün Belgeleri / Certification

- Standard format
Standart format 800 mm x 1200 mm
- Materyal
Material UPGM, polyester reçine / cam elyaf mat 7735
UPGM, polyester resin / glass fiber mat 7735
- Üretim Modeli
Norm EN 60893 kapsamında UPGM 203 üretimi; DIN 7735: HM 2472
UPGM 203 according to EN 60893; HM 2472 according to DIN 7735
- Üretim Tipi
Type of production Sıkıştırma
Pressed
- Renk
Colour Standart Ral 7035 / İstenlen renk koduna göre üretim yapılmaktadır.
Standart color; Ral 7035 / given the color code, each color can be produced
- Kalınlık
Thickness 3 mm to 50 mm
- Uygun çalışma sıcaklığı
Working temperature -40 + 155 °C
-40 to + 155 °C
- Yoğunluk
Density 1.9 g/cm³



Cam elyaf mat ve polyeester reçineden oluşan halojen gazı salgılamayan UPGM 203, hem elektriksel hem de mekanik alanlarda çok çeşitli uygulamalar için kullanılmaktadır. Yüksek mekanik ve termal özellikleri nedeniyle, F Sınıfı bir malzemenin gerekli olduğu elektrik panelleri, transformatörler ve daha fazlasının içinde kullanım için idealdir. Ürün, V0'a göre UL94 yanmazlık testine uygundur ve yalıtıklık testine de sahiptir. Müşterilerimizin isteğine göre ürünü SMC veya el yatırması üretim yöntemleriyle üretebilmekteyiz.

Glass mat and unsaturated polyester resin bulk, special laminated halogen-free UPGM 203 is used for many kinds of both electrical and mechanical applications. Due to its excellent mechanical and thermal qualities it is used in electrical switchboards, transformers and many more, where a Class F material is a must. The product complies with UL94 flame resistance test to V0, as well as having a tracking test. UPGM 203 can be manufactured with both SMC and Hand Lay-up method in our factory.

UPGM 203 EL YATIRMASI / UPGM 203 HAND LAY UP

Kod / Code	Ürün Tanımı / Product Name	Ölçüler / Dimension (mm)			Birim Fiyat / Unit Price (Adet/pcs)
		Kalınlık Thickness (mm)	En Width (mm)	Boy Height (mm)	
İRTU-CEP038001200	CAM ELYAF POLYESTER PLAKA FIBER GLASS PLATE	3	800	1200	🔗
İRTU-CEP058001200		5	800	1200	🔗
İRTU-CEP108001200		10	800	1200	🔗
İRTU-CEP158001200		15	800	1200	🔗
İRTU-CEP208001200		20	800	1200	🔗
İRTU-CEP258001200		25	800	1200	🔗
İRTU-CEP308001200		30	800	1200	🔗
İRTU-CET030301200	CAM ELYAF POLYESTER TAKOZ FIBER GLASS PLATE	3	30	1200	🔗
İRTU-CET030401200		3	40	1200	🔗
İRTU-CET030501200		3	50	1200	🔗
İRTU-CET030601200		3	60	1200	🔗
İRTU-CET050301200	CAM ELYAF POLYESTER TAKOZ FIBER GLASS PLATE	5	30	1200	🔗
İRTU-CET050401200		5	40	1200	🔗
İRTU-CET050501200		5	50	1200	🔗
İRTU-CET050601200		5	60	1200	🔗
İRTU-CET100301200	CAM ELYAF POLYESTER TAKOZ FIBER GLASS PLATE	10	30	1200	🔗
İRTU-CET100401200		10	40	1200	🔗
İRTU-CET100501200		10	50	1200	🔗
İRTU-CET100601200		10	60	1200	🔗
İRTU-CET150301200	CAM ELYAF POLYESTER TAKOZ FIBER GLASS PLATE	15	30	1200	🔗
İRTU-CET150401200		15	40	1200	🔗
İRTU-CET150501200		15	50	1200	🔗
İRTU-CET150601200		15	60	1200	🔗
İRTU-CET200301200	CAM ELYAF POLYESTER TAKOZ FIBER GLASS PLATE	20	30	1200	🔗
İRTU-CET200401200		20	40	1200	🔗
İRTU-CET200501200		20	50	1200	🔗
İRTU-CET200601200		20	60	1200	🔗
İRTU-CET250301200	CAM ELYAF POLYESTER TAKOZ FIBER GLASS PLATE	25	30	1200	🔗
İRTU-CET250401200		25	40	1200	🔗
İRTU-CET250501200		25	50	1200	🔗
İRTU-CET250601200		25	60	1200	🔗
İRTU-CET300301200	CAM ELYAF POLYESTER TAKOZ FIBER GLASS PLATE	30	30	1200	🔗
İRTU-CET300401200		30	40	1200	🔗
İRTU-CET300501200		30	50	1200	🔗
İRTU-CET300601200		30	60	1200	🔗
İRTU-CET500301200	CAM ELYAF POLYESTER TAKOZ FIBER GLASS PLATE	50	30	1200	🔗
İRTU-CET500401200		50	40	1200	🔗
İRTU-CET500501200		50	50	1200	🔗
İRTU-CET500601200		50	60	1200	🔗





UPGM 203 SMC ÜRETİM / UPGM 203 SMC PRODUCTION

Kod / Code	Ürün Tanımı / Product Name	Ölçüler / Dimension (mm)			Birim Fiyat / Unit Price (Adet/pcs)
		Kalınlık Thickness (mm)	En Width (mm)	Boy Height (mm)	
İRTU-SMCP038001200	SMC POLYESTER PLAKA SMC FIBER GLASS PLATE	3	800	1200	📄
İRTU-SMCP058001200		5	800	1200	📄
İRTU-SMCP108001200		10	800	1200	📄
İRTU-SMCP158001200		15	800	1200	📄
İRTU-SMCP208001200		20	800	1200	📄
İRTU-SMCP258001200		25	800	1200	📄
İRTU-SMCP308001200		30	800	1200	📄
İRTU-SMCT030301200	SMC POLYESTER TAKOZ SMC FIBER GLASS PLATE	3	30	1200	📄
İRTU-SMCT030401200		3	40	1200	📄
İRTU-SMCT030501200		3	50	1200	📄
İRTU-SMCT030601200		3	60	1200	📄
İRTU-SMCT050301200	SMC POLYESTER TAKOZ SMC FIBER GLASS PLATE	5	30	1200	📄
İRTU-SMCT050401200		5	40	1200	📄
İRTU-SMCT050501200		5	50	1200	📄
İRTU-SMCT050601200		5	60	1200	📄
İRTU-SMCT100301200	SMC POLYESTER TAKOZ SMC FIBER GLASS PLATE	10	30	1200	📄
İRTU-SMCT100401200		10	40	1200	📄
İRTU-SMCT100501200		10	50	1200	📄
İRTU-SMCT100601200		10	60	1200	📄
İRTU-SMCT150301200	SMC POLYESTER TAKOZ SMC FIBER GLASS PLATE	15	30	1200	📄
İRTU-SMCT150401200		15	40	1200	📄
İRTU-SMCT150501200		15	50	1200	📄
İRTU-SMCT150601200		15	60	1200	📄
İRTU-SMCT200301200	SMC POLYESTER TAKOZ SMC FIBER GLASS PLATE	20	30	1200	📄
İRTU-SMCT200401200		20	40	1200	📄
İRTU-SMCT200501200		20	50	1200	📄
İRTU-SMCT200601200		20	60	1200	📄
İRTU-SMCT250301200	SMC POLYESTER TAKOZ SMC FIBER GLASS PLATE	25	30	1200	📄
İRTU-SMCT250401200		25	40	1200	📄
İRTU-SMCT250501200		25	50	1200	📄
İRTU-SMCT250601200		25	60	1200	📄
İRTU-SMCT300301200	SMC POLYESTER TAKOZ SMC FIBER GLASS PLATE	30	30	1200	📄
İRTU-SMCT300401200		30	40	1200	📄
İRTU-SMCT300501200		30	50	1200	📄
İRTU-SMCT300601200		30	60	1200	📄
İRTU-SMCT500301200	SMC POLYESTER TAKOZ SMC FIBER GLASS PLATE	50	30	1200	📄
İRTU-SMCT500401200		50	40	1200	📄
İRTU-SMCT500501200		50	50	1200	📄
İRTU-SMCT500601200		50	60	1200	📄





CAM ELYAF (UPGM-203) UYGULAMA ALANLARI

APPLICATION AREAS OF
FIBER GLASS PLATES

PANO İÇİ GEÇİŞ
MONTAGE OF IN PANEL



İZOLASYON
INSULATION

ANA BARA SABİTLEME
FIXING TO MAIN BUSBAR



ŞALTER AYAKLARI SABİTLEME
FIXING SWITCH FEET

OG İZOLATÖRLER ve EKİPMANLARI



OG İZOLATÖRLER

- Dahili Tip Mesnet İzolatörler.
- Kapasitif Gerilim İzolatörler.

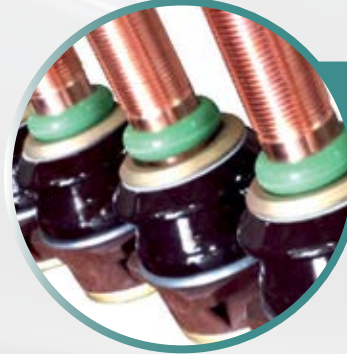

TRAFO BUSHING

- Yağlı tip dağıtım ve güç trafo-larında, Bushing altında kullanılır.
- 250A - 4500A AG Bushing İzolatör



KABLO TUTUCULAR

- Hücre İçi Kablo Tutucu.



KABLO KÖRÜKLERİ

- Hücre İçi Kablo Körüğü.
- 180 x 64 mm Plastik Körük.

Dahili Tip O.G Mesnet İzolatörü

Post Insulators



Kod / Code	Tip / Type		Um (kV)	Min. Bükme Min. Bending	Ölçüler / Measurement										Min. Krepaj mm	Perde Sheds	Birim Fiyatı / Price (Adet / PCS)
	VDE	IEC			N	H	e	D	a	b	c	t1	t2	t3			
İRTU-M1002	10 N 500	JO4-75	12	4000	130	36	62	M16	M12	M6	24	15	14	36	160	5	
İRTU-M1003	10 N 1000	JO8-75			8000	130	46	80	M20	M16	M10	27	33	15	42	187	5
İRTU-M2001	20 N 500	JO4-125	24	4000	130	36	74	M16	M12	M6	33	15	14	50	320	8	
İRTU-M2002	20 N 1000	JO8-125			8000	210	46	86	M20	M16	M10	27	33	15	44	320	8
İRTU-M3001	30 N 500	JO4-170	36	4000	300	36	76	M16	M12	M6	33	15	14	54	445	11	
İRTU-M3002	30 N 1000	JO10-170			10000	300	46	99	M24	M16	M10	36	33	15	60	445	11

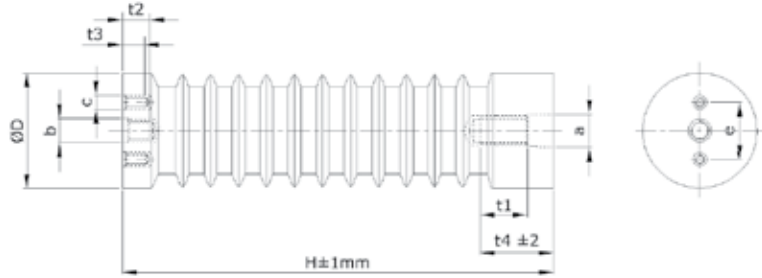

Dahili Tip Orta Gerilim Kapasitif Gerilim Mesnet İzolatörler

Voltage Divider Post Insulator



Kod / Code	Tip / Type	Um (kV)	Min. Bükme Min. Bending	Ölçüler / Measurement										Min. Krepaj mm	Perde Sheds	Birim Fiyatı / Price (Adet / PCS)	
				N	H	e	D	s	a	b	v	t1	t2				t3
İRTU-DG1201	10 N 10000	12	8000	130	46	80	30	M20	M16	M10	17	20	17	20	160	5	
İRTU-DG2401	20 N 500			4000	210	36	74	30	M20	M12	M6	35	20	14	47	320	5
İRTU-DG2402	20 N 10000	24	8000	210	46	86	30	M16	M16	M10	35	27	20	47	320	8	
İRTU-DG3601	30 N 500			4000	300	36	82	34	M24	M12	M6	19	22	17	50	435	11
İRTU-DG3602	30 N 1000	36	8000	300	46	99	34	M24	M16	M10	36	21	17	57	435	11	

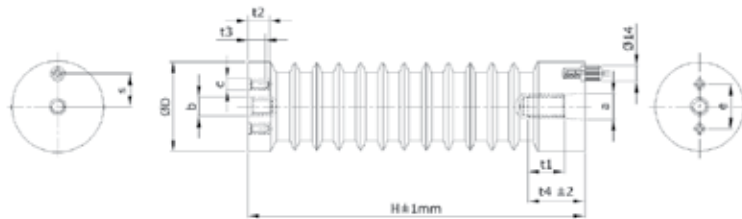



- Yağlı tip dağıtım ve güç trafolarında bushing altı kullanılır.
Used in oiled type distribution and power transformers.
- Plastik malzemeden üretilmektedir.
Made of plastic material.

Kod / Code	Tip / Type	Ürün Tanımı / Product Name	Kutu Adedi / Box Qty	Birim Fiyat Price (Adet/pcs)
İRTU-BS250	DT 250	250AAG Bushing İzolatör	100	41,10 TL



İRTU-BS630	DT 630	630AAG Bushing İzolatör	100	74,25 TL
------------	--------	-------------------------	-----	----------

İRTU-BS1000	DT 1000	1000AAG Bushing İzolatör	100	202,40 TL
-------------	---------	--------------------------	-----	-----------

İRTU-BS2000	DT 2000	2000AAG Bushing İzolatör	100	340,85 TL
-------------	---------	--------------------------	-----	-----------

İRTU-BS3150	DT 3150	3150AAG Bushing İzolatör	100	405,10 TL
-------------	---------	--------------------------	-----	-----------

İRTU-BS4500	DT 4500	4500AAG Bushing İzolatör	100	900,95 TL
-------------	---------	--------------------------	-----	-----------

Orta Gerilim Hücre Kablo Tutucu

Medium Voltage Switchgear Cable Holder



Kod / Code	Ürün Tanımı / Product Name	Kutu Adedi Takım / Box Qty	Birim Fiyat Unit Price (adet/pcs)
İRTU-PKT1020	Plastik Kablo Tutucu / Plastic Cable Holder	50	136,50 TL

- Orta gerilim hücre içinde kablo girişlerinde kullanılır. / Used in MV cable entries.
- Yanmaz ve halogen-free özelliklidir. / Inflammable and halogen-free
- Ø 50-80 mm kabloya uygundur. / Compatible for Ø 50-80 mm cable.

Orta Gerilim Hücre Kablo Köpüğü

Medium Voltage Switchgear Cable Bellows



Kod / Code	Ürün Tanımı / Product Name	Kutu Adedi Box Qty	Birim Fiyat Unit Price (adet/pcs)
İRTU-PKT 1040	Ø60 mm Plastik Kablo Köpüğü / Plastic Cable Bellows	100	70,40 TL
İRTU-PKT 1030	Ø100 mm Plastik Kablo Köpüğü / Plastic Cable Bellows	120	93,75 TL

- Orta gerilim hücre içinde kablo girişlerinde sızdırmalara karşı kullanılır.
Used in MV cable entries against leaks

Körük

Bellows



Kod / Code	Ürün Tanımı / Product Name	Kutu Adedi / Box Qty	Birim Fiyat Unit Price (adet/pcs)
İRTU-PKT1050	Plastik Körük / Plastic Bellows (180x64mm)	60	156,00 TL
İRTU-PKT1050 VO	Plastik Körük Yanmaz (VO) / Plastic Bellows Fireproof (VO) (180x64mm)	60	234,00 TL

DAĞITIM ÜRÜNLERİ ve TOPRAKLAMA ÇÖZÜMLERİ

DAĞITIM ÜNİTELERİ



- 80A - 125A - 160A - 200A - 250A.
- Tek, İki, Üç ve Dört Kutuplu Üniteler.
- Monoblok Güç Dağıtım Blokları.

BAĞLANTI KLEMENSLERİ



- Bakır Bağlantı Klemensleri.
- Geçmeli Bağlantı Klemensleri.
- Yay Baskılı Bağlantı Klemensleri.
- U Klemensler.
- Kapı Topraklama Baraları.

TOPRAKLAMA KLEMENSLERİ



- 80A - 125A - 160A.
- Topraklama Klemensleri (Ayaksız).
- Nötr Klemensler (Ayaklı).
- İzalasyonlu Topraklama Klemensleri

BAĞLANTI BARALARI



- Flexi Bağlantı Baraları.
- İzole Örgülü Bağlantı Baraları.
- İzoleli Esnek Baralar.

TOPRAKLAMA BARALARI



- Bakır Topraklama Baraları.
- Vidalı Bara Mesnetleri.
- Plastik Ayaklı Topraklama Barası.
- Eş Potansiyel Baralar.

OTOMAT BARALARI

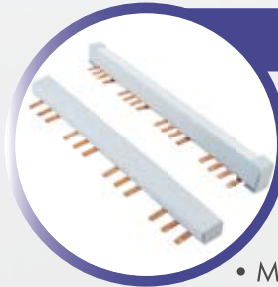

- Monofaze Otomat Baraları.
- İki Fazlı Otomat Baraları.
- Trifaze Otomat Baraları.
- Üç Faz + Nötr Otomat Baraları.
- L1+N - L2+N - L3+N Baralar.
- Motor Koruma Baraları.

80A Tek Kutuplu Dağıtım Ünitesi (6,5x9 mm)
80A One Pole Distribution Unit (6,5x9 mm)

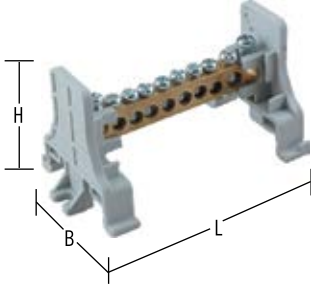

Kod / Code	Ürün Tanımı / Product Name	L	B	H	Koli Adedi / Box Qty.	Birim Fiyat / Unit Price (Adet/pcs)
İRTU-550204	2+4 6 DELİKLİ ÜNİTE / 2+4 6 HOLE UNITS	60	42	44	125	91,50 TL
İRTU-550205	2+5 7 DELİKLİ ÜNİTE / 2+5 7 HOLE UNITS	66	42	44	120	102,00 TL
İRTU-550208	2+8 10 DELİKLİ ÜNİTE / 2+8 10 HOLE UNITS	82	42	44	100	112,50 TL
İRTU-550210	2+10 12 DELİKLİ ÜNİTE / 2+10 12 HOLE UNITS	100	42	44	90	135,00 TL
İRTU-550213	2+13 15 DELİKLİ ÜNİTE / 2+13 15 HOLE UNITS	115	42	44	75	150,00 TL
İRTU-550218	2+18 20 DELİKLİ ÜNİTE / 2+18 20 HOLE UNITS	142	42	44	50	213,00 TL
İRTU-550223	2+23 25 DELİKLİ ÜNİTE / 2+23 25 HOLE UNITS	175	42	44	40	271,50 TL
İRTU-550228	2+28 30 DELİKLİ ÜNİTE / 2+28 30 HOLE UNITS	215	42	44	30	315,00 TL

80A Tek Kutuplu Kapaklı Dağıtım Ünitesi (6,5x9 mm)
80A One Pole Covered Distribution Unit (6,5x9 mm)



Kod / Code	Ürün Tanımı / Product Name	L	B	H	Koli Adedi / Box Qty.	Birim Fiyat / Unit Price (Adet/pcs)
İRTU-551204	2+4 6 DELİKLİ ÜNİTE / 2+4 6 HOLE UNITS	60	42	44	110	105,00 TL
İRTU-551205	2+5 7 DELİKLİ ÜNİTE / 2+5 7 HOLE UNITS	66	42	44	100	114,00 TL
İRTU-551208	2+8 10 DELİKLİ ÜNİTE / 2+8 10 HOLE UNITS	82	42	44	80	150,00 TL
İRTU-551210	2+10 12 DELİKLİ ÜNİTE / 2+10 12 HOLE UNITS	100	42	44	70	172,50 TL
İRTU-551213	2+13 15 DELİKLİ ÜNİTE / 2+13 15 HOLE UNITS	115	42	44	50	213,00 TL
İRTU-551218	2+18 20 DELİKLİ ÜNİTE / 2+18 20 HOLE UNITS	142	42	44	40	262,50 TL
İRTU-551223	2+23 25 DELİKLİ ÜNİTE / 2+23 25 HOLE UNITS	175	42	44	30	277,50 TL
İRTU-551228	2+28 30 DELİKLİ ÜNİTE / 2+28 30 HOLE UNITS	215	42	44	20	315,00 TL

80A 2 Kutuplu Dağıtım Ünitesi (6,5x9 mm)
80A 2 Pole Distribution Unit (6,5x9 mm)



Kod / Code	Ürün Tanımı / Product Name	L	B	H	Koli Adedi / Box Qty.	Birim Fiyat / Unit Price (Adet/pcs)
İRTU-650205	2+5 DELİKLİ / 2+5 HOLE	65	45	47	22	200,00 TL
İRTU-650208	2+8 DELİKLİ / 2+8 HOLE	88	45	47	15	237,50 TL
İRTU-650210	2+10 DELİKLİ / 2+10 HOLE	102	45	47	14	256,25 TL
İRTU-650213	2+13 DELİKLİ / 2+13 HOLE	126	45	47	12	337,50 TL
İRTU-650218	2+18 DELİKLİ / 2+18 HOLE	162	45	47	6	437,50 TL
İRTU-650220	2+20 DELİKLİ / 2+20 HOLE	175	45	47	6	456,25 TL

80A 4 Kutuplu Dağıtım Ünitesi (6,5x9 mm)
80A 4 Pole Distribution Unit (6,5x9 mm)



Kod / Code	Ürün Tanımı / Product Name	L	B	H	Koli Adedi / Box Qty.	Birim Fiyat / Unit Price (Adet/pcs)
İRTU-651205	2+5 DELİKLİ / 2+5 HOLE	65	90	50	10	450,00 TL
İRTU-651208	2+8 DELİKLİ / 2+8 HOLE	87	90	50	8	468,75 TL
İRTU-651210	2+10 DELİKLİ / 2+10 HOLE	102	90	50	6	518,75 TL
İRTU-651213	2+13 DELİKLİ / 2+13 HOLE	126	90	50	5	637,50 TL
İRTU-651218	2+18 DELİKLİ / 2+18 HOLE	162	90	50	4	793,75 TL
İRTU-651220	2+20 DELİKLİ / 2+20 HOLE	175	90	50	4	837,50 TL
İRTU-651223	2+23 DELİKLİ / 2+23 HOLE	197	90	50	4	931,25 TL

125A Tek Kutuplu Dağıtım Ünitesi (7x12 mm)
125A One Pole Distribution Unit (7x12 mm)



Kod / Code	Ürün Tanımı / Product Name	L	B	H	Koli Adedi / Box Qty.	Birim Fiyat / Unit Price (Adet/pcs)
İRTU-730205	2+5 7 DELİKLİ ÜNİTE / 2+5 7 HOLE UNITS	76	44	42	65	120,00 TL
İRTU-730208	2+8 10 DELİKLİ ÜNİTE / 2+8 10 HOLE UNITS	100	44	42	48	129,00 TL
İRTU-730210	2+10 12 DELİKLİ ÜNİTE / 2+10 12 HOLE UNITS	115	44	42	45	142,50 TL
İRTU-730213	2+13 15 DELİKLİ ÜNİTE / 2+13 15 HOLE UNITS	135	44	42	40	217,50 TL
İRTU-730218	2+18 20 DELİKLİ ÜNİTE / 2+18 20 HOLE UNITS	170	44	42	30	262,50 TL
İRTU-730220	2+20 22 DELİKLİ ÜNİTE / 2+20 22 HOLE UNITS	185	44	42	30	294,00 TL
İRTU-730223	2+23 25 DELİKLİ ÜNİTE / 2+23 25 HOLE UNITS	207	44	42	25	315,00 TL
İRTU-730228	2+28 30 DELİKLİ ÜNİTE / 2+28 30 HOLE UNITS	245	44	42	20	363,00 TL

125A Tek Kutuplu Kapaklı Dağıtım Ünitesi (7x12 mm)
125A One Pole Covered Distribution Unit (7x12 mm)



Kod / Code	Ürün Tanımı / Product Name	L	B	H	Koli Adedi / Box Qty.	Birim Fiyat / Unit Price (Adet/pcs)
İRTU-731205	2+5 7 DELİKLİ ÜNİTE / 2+5 7 HOLE UNITS	76	44	42	75	135,00 TL
İRTU-731208	2+8 10 DELİKLİ ÜNİTE / 2+8 10 HOLE UNITS	100	44	42	60	157,50 TL
İRTU-731210	2+10 12 DELİKLİ ÜNİTE / 2+10 12 HOLE UNITS	115	44	42	50	180,00 TL
İRTU-731213	2+13 15 DELİKLİ ÜNİTE / 2+13 15 HOLE UNITS	135	44	42	40	229,50 TL
İRTU-731218	2+18 20 DELİKLİ ÜNİTE / 2+18 20 HOLE UNITS	170	44	42	30	285,00 TL
İRTU-731220	2+20 22 DELİKLİ ÜNİTE / 2+20 22 HOLE UNITS	185	44	42	30	315,00 TL
İRTU-731223	2+23 25 DELİKLİ ÜNİTE / 2+23 25 HOLE UNITS	207	44	42	20	363,00 TL
İRTU-731228	2+28 30 DELİKLİ ÜNİTE / 2+28 30 HOLE UNITS	245	44	42	20	417,00 TL

125A 2 Kutuplu Dağıtım Ünitesi (7x12 mm)
125A 2 Pole Distribution Unit (7x12 mm)



Kod / Code	Ürün Tanımı / Product Name	L	B	H	Koli Adedi / Box Qty.	Birim Fiyat / Unit Price (Adet/pcs)
İRTU-720205	2+5 DELİKLİ / 2+5 HOLE	65	45	47	22	231,25 TL
İRTU-720208	2+8 DELİKLİ / 2+8 HOLE	88	45	47	15	250,00 TL
İRTU-720210	2+10 DELİKLİ / 2+10 HOLE	102	45	47	14	275,00 TL
İRTU-720213	2+13 DELİKLİ / 2+13 HOLE	126	45	47	12	356,25 TL
İRTU-720218	2+18 DELİKLİ / 2+18 HOLE	162	45	47	6	446,25 TL
İRTU-720220	2+20 DELİKLİ / 2+20 HOLE	175	45	47	6	487,50 TL

125A 4 Kutuplu Dağıtım Ünitesi (7x12 mm)
125A 4 Pole Distribution Unit (7x12 mm)



Kod / Code	Ürün Tanımı / Product Name	L	B	H	Koli Adedi / Box Qty.	Birim Fiyat / Unit Price (Adet/pcs)
İRTU-741205	2+5 DELİKLİ / 2+5 HOLE	65	90	50	29	492,50 TL
İRTU-741208	2+8 DELİKLİ / 2+8 HOLE	87	90	50	16	525,00 TL
İRTU-741210	2+10 DELİKLİ / 2+10 HOLE	102	90	50	12	562,50 TL
İRTU-741213	2+13 DELİKLİ / 2+13 HOLE	126	90	50	10	687,50 TL
İRTU-741218	2+18 DELİKLİ / 2+18 HOLE	162	90	50	8	875,00 TL
İRTU-741220	2+20 DELİKLİ / 2+20 HOLE	175	90	50	8	906,25 TL
İRTU-741223	2+23 DELİKLİ / 2+23 HOLE	197	90	50	8	1.075,00 TL

125A 4 Kutuplu Dağıtım Ünitesi (7x12 mm)
125A 4 Pole Distribution Unit (7x12 mm)

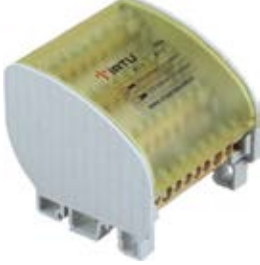

Kod / Code	Ürün Tanımı / Product Name	L	B	H	Koli Adedi Box Qty.	Birim Fiyat Unit Price (Adet/pcs)
IRTU-740205	2+5 DELİKLİ / 2+5 HOLE	65	90	74	10	517,50 TL
IRTU-740208	2+8 DELİKLİ / 2+8 HOLE	87	90	74	8	562,50 TL
IRTU-740210	2+10 DELİKLİ / 2+10 HOLE	102	90	74	6	622,50 TL
IRTU-740213	2+13 DELİKLİ / 2+13 HOLE	126	90	74	5	772,50 TL
IRTU-740218	2+18 DELİKLİ / 2+18 HOLE	162	90	74	4	1.005,00 TL
IRTU-740220	2+20 DELİKLİ / 2+20 HOLE	175	90	74	4	1.072,50 TL
IRTU-740223	2+23 DELİKLİ / 2+23 HOLE	197	90	74	4	1.237,50 TL

125A 3 Kutuplu Dağıtım Ünitesi (7x12 mm)
125A 3 Poles Distribution Unit (7x12 mm)



Kod / Code	Ürün Tanımı / Product Name	L	B	H	Koli Adedi Box Qty.	Birim Fiyat Unit Price (Adet/pcs)
IRTU-103205	2+5 DELİKLİ / 2+5 HOLE	88	130	55	12	585,00 TL
IRTU-103208	2+8 DELİKLİ / 2+8 HOLE	110	130	55	8	630,00 TL
IRTU-103210	2+10 DELİKLİ / 2+10 HOLE	124	130	55	8	682,50 TL
IRTU-103213	2+13 DELİKLİ / 2+13 HOLE	150	130	55	6	832,50 TL
IRTU-103218	2+18 DELİKLİ / 2+18 HOLE	185	130	55	4	1.050,00 TL
IRTU-103220	2+20 DELİKLİ / 2+20 HOLE	200	130	55	4	1.140,00 TL

125A 4 Kutuplu Dağıtım Ünitesi (7x12 mm)
125A 4 Poles Distribution Unit (7x12 mm)



Kod / Code	Ürün Tanımı / Product Name	L	B	H	Koli Adedi Box Qty.	Birim Fiyat Unit Price (Adet/pcs)
IRTU-104205	2+5 DELİKLİ / 2+5 HOLE	88	144	55	12	667,50 TL
IRTU-104208	2+8 DELİKLİ / 2+8 HOLE	110	144	55	8	765,00 TL
IRTU-104210	2+10 DELİKLİ / 2+10 HOLE	124	144	55	8	885,00 TL
IRTU-104213	2+13 DELİKLİ / 2+13 HOLE	150	144	55	6	1.057,50 TL
IRTU-104218	2+18 DELİKLİ / 2+18 HOLE	185	144	55	4	1.357,50 TL
IRTU-104220	2+20 DELİKLİ / 2+20 HOLE	200	144	55	4	1.417,50 TL

125A 5 Kutuplu Dağıtım Ünitesi (7x12 mm)
125A 5 Poles Distribution Unit (7x12 mm)

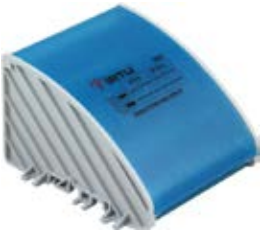

Kod / Code	Ürün Tanımı / Product Name	L	B	H	Koli Adedi Box Qty.	Birim Fiyat Unit Price (Adet/pcs)
IRTU-105205	2+5 DELİKLİ / 2+5 HOLE	88	151	95	8	765,00 TL
IRTU-105208	2+8 DELİKLİ / 2+8 HOLE	110	151	95	4	885,00 TL
IRTU-105210	2+10 DELİKLİ / 2+10 HOLE	124	151	95	4	1.057,50 TL
IRTU-105213	2+13 DELİKLİ / 2+13 HOLE	150	151	95	4	1.117,50 TL
IRTU-105218	2+18 DELİKLİ / 2+18 HOLE	185	151	95	4	1.462,50 TL
IRTU-105220	2+20 DELİKLİ / 2+20 HOLE	200	151	95	4	1.500,00 TL

160A Tek Kutuplu Dağıtım Ünitesi (10x15 mm)
160A One Pole Distribution Unit (10x15 mm)



Kod / Code	Ürün Tanımı / Product Name	L	B	H	Koli Adedi / Box Qty.	Birim Fiyat Unit Price (Adet/pcs)
İRTU-150205	2+5 7 DELİKLİ ÜNİTE / 2+5 7 HOLE UNITS	110	40	40	25	309,50 TL
İRTU-150208	2+8 10 DELİKLİ ÜNİTE / 2+8 10 HOLE UNITS	120	40	40	25	379,20 TL
İRTU-150210	2+10 12 DELİKLİ ÜNİTE / 2+10 12 HOLE UNITS	155	40	40	15	433,20 TL
İRTU-150213	2+13 15 DELİKLİ ÜNİTE / 2+13 15 HOLE UNITS	180	40	40	15	516,00 TL
İRTU-150218	2+18 20 DELİKLİ ÜNİTE / 2+18 20 HOLE UNITS	220	40	40	10	672,00 TL
İRTU-150220	2+20 22 DELİKLİ ÜNİTE / 2+20 22 HOLE UNITS	240	40	40	10	720,00 TL

160A 3 Kutuplu Dağıtım Ünitesi (10x15 mm)
160A 3 Poles Distribution Unit (10x15 mm)



Kod / Code	Ürün Tanımı / Product Name	L	B	H	Koli Adedi Box Qty.	Birim Fiyat Unit Price (Adet/pcs)
İRTU-151205	2+5 DELİKLİ / 2+5 HOLE	105	130	55	12	832,50 TL
İRTU-151208	2+8 DELİKLİ / 2+8 HOLE	145	130	55	8	1.237,50 TL
İRTU-151210	2+10 DELİKLİ / 2+10 HOLE	165	130	55	8	1.485,00 TL
İRTU-151213	2+13 DELİKLİ / 2+13 HOLE	200	130	55	6	1.815,00 TL
İRTU-151218	2+18 DELİKLİ / 2+18 HOLE	255	130	55	4	2.475,00 TL
İRTU-151220	2+20 DELİKLİ / 2+20 HOLE	275	130	55	4	2.730,00 TL

160A 4 Kutuplu Dağıtım Ünitesi (10x15 mm)
160A 4 Poles Distribution Unit (10x15 mm)



Kod / Code	Ürün Tanımı / Product Name	L	B	H	Koli Adedi Box Qty.	Birim Fiyat Unit Price (Adet/pcs)
İRTU-152205	2+5 DELİKLİ / 2+5 HOLE	105	144	55	12	945,00 TL
İRTU-152208	2+8 DELİKLİ / 2+8 HOLE	145	144	55	8	1.395,00 TL
İRTU-152210	2+10 DELİKLİ / 2+10 HOLE	165	144	55	8	1.575,00 TL
İRTU-152213	2+13 DELİKLİ / 2+13 HOLE	200	144	55	6	2.047,50 TL
İRTU-152218	2+18 DELİKLİ / 2+18 HOLE	255	144	55	4	2.662,50 TL
İRTU-152220	2+20 DELİKLİ / 2+20 HOLE	275	144	55	4	2.752,50 TL

160A 5 Kutuplu Dağıtım Ünitesi (10x15 mm)
160A 5 Poles Distribution Unit (10x15 mm)

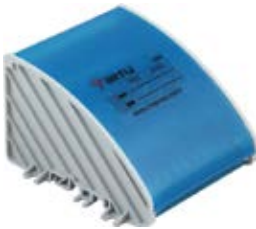

Kod / Code	Ürün Tanımı / Product Name	L	B	H	Koli Adedi Box Qty.	Birim Fiyat Unit Price (Adet/pcs)
İRTU-153205	2+5 DELİKLİ / 2+5 HOLE	105	151	95	8	1.155,00 TL
İRTU-153208	2+8 DELİKLİ / 2+8 HOLE	145	151	95	4	1.575,00 TL
İRTU-153210	2+10 DELİKLİ / 2+10 HOLE	165	151	95	4	1.890,00 TL
İRTU-153213	2+13 DELİKLİ / 2+13 HOLE	200	151	95	4	2.362,50 TL
İRTU-153218	2+18 DELİKLİ / 2+18 HOLE	255	151	95	4	3.150,00 TL
İRTU-153220	2+20 DELİKLİ / 2+20 HOLE	275	151	95	4	3.465,00 TL



250A 4 Kutuplu Dağıtım Ünitesi (4x20 mm Bakır)
250A 4 Poles Distribution Unit (4x20 mm Copper)

Kod / Code	Ürün Tanımı / Product Name	L	B	H	Koli Adedi Box Qty.	Birim Fiyat Unit Price (Adet/pcs)
IRTU-425007	1 GİRİŞ - 7 ÇIKIŞ / 1 INPUT - 7 OUTPUT	220	150	95	6	2.062,50 TL
IRTU-425010	1 GİRİŞ - 10 ÇIKIŞ / 1 INPUT - 10 OUTPUT	280	150	39	4	2.182,50 TL
IRTU-425014	1 GİRİŞ - 14 ÇIKIŞ / 1 INPUT - 14 OUTPUT	314	150	39	4	2.662,50 TL



Formlama İzolatör Ayak (3/4 Kutuplu - Max 40x10 mm Bara İle Kullanılır)
Forming Insulator Foot (3/4 Pole - Max 40x10 mm Used With Busbar)

Kod / Code	Ürün Tanımı / Product Name	Koli Adedi Box Qty.	Birim Fiyat (Takım) Unit Price (Set / 2 pcs)
İRTPF-4003	3 Kutuplu Formlama İzolatörü (Max. 40x10)	1	474,50 TL
İRTPF-4004	4 Kutuplu Formlama İzolatörü (Max. 40x10)	1	589,00 TL

* Sağ + Sol Ünite kombinasyonu ile minimum 1 set olarak sevk edilir.

* Shipped as minimum 1 set with Right + Left Unit combination



UL 94 V0 Yanmazlık seviyesi, ergonomik ve kompakt yapı, yüksek kısa devre güçlerine karşı geliştirilmiş tasarımıyla kısadevre dinamikleri ve kamçılamalara karşı maksimum emniyetle güvenle ve estetik bara dizaynı sağlayacak form 1-2-3-4 seçenekleriyle kolay montaj ve işletme çözümü sunar.



With its UL 94 V0 non-flammability level, ergonomic and compact structure, designed against high short-circuit forces, it provides a safe and aesthetic busbar designed with maximum safety against cross-circuit dynamics and gnawing. It offers easy assembly and operation solution in Form1-2-3-4 options.

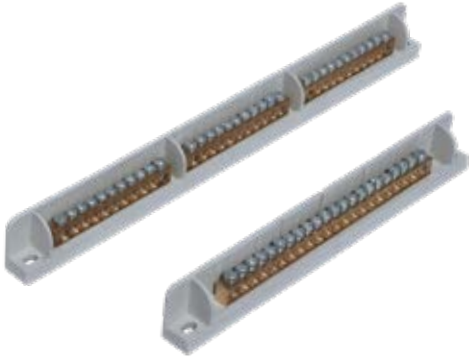

Tüm ürünler; All products;

- Vidalar Cr+3 kaplamalıdır.
Screws are coated with cr+3.
- M5 58 pirinç malzemeden üretilmektedir.
Produced by M5 58 brass material.
- Plastik parçalar yanmaz (VO)'dür.
Plastic parts are non-flammable (VO).
- Plastik izolasyon parçaları birbirine geçme olup değişik ölçülerde yapılabilir.
The plastic parts are intertwined and can be made in different sizes.

Tek Kutuplu İzolasyonlu Topraklama Klemensi 80A (6,5x9 mm) One Pole Insulated Panel Grounding Terminal 80A (6,5x9 mm)

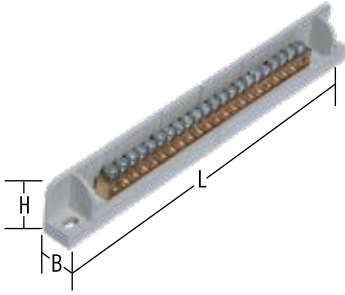

Kod / Code	Ürün Tanımı / Product Name	L	B	H	Koli Adedi / Box Qty.	Birim Fiyat / Unit Price (Adet/pcs)
İRTU-TKG10010	1x10 DELİK TEK KUTUP / 1x10 HOLE ONE POLE	128	115	25.65	100	105,00 TL
İRTU-TKG10011	1x11 DELİK TEK KUTUP / 1x11 HOLE ONE POLE	128	115	25.65	100	113,40 TL
İRTU-TKG10015	1x15 DELİK TEK KUTUP / 1x15 HOLE ONE POLE	128	115	25.65	100	147,00 TL
İRTU-TKG10020	1x20 DELİK TEK KUTUP / 1x20 HOLE ONE POLE	183	168	25.65	100	173,25 TL
İRTU-TKG10030	1x30 DELİK TEK KUTUP / 1x30 HOLE ONE POLE	225	213	25.65	100	215,25 TL

İki Kutuplu İzolasyonlu Topraklama Klemensi 80A (6,5x9 mm) Two Pole Insulated Panel Grounding Terminal 80A (6,5x9 mm)

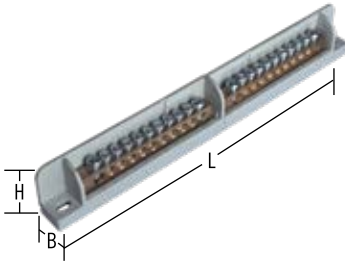

Kod / Code	Ürün Tanımı / Product Name	L	B	H	Koli Adedi / Box Qty.	Birim Fiyat / Unit Price (Adet/pcs)
İRTU-TKG20008	2x8 DELİK İKİ KUTUP / 2x8 HOLE TWO POLE	182	168	25.65	100	136,50 TL
İRTU-TKG20011	2x11 DELİK İKİ KUTUP / 2x11 HOLE TWO POLE	182	168	25.65	100	168,00 TL
İRTU-TKG20015	2x15 DELİK İKİ KUTUP / 2x15 HOLE TWO POLE	260	245	25.65	100	243,00 TL

Üç Kutuplu İzolasyonlu Topraklama Klemensi 80A - 125A Three Pole Insulated Panel Grounding Terminal 80A - 125A

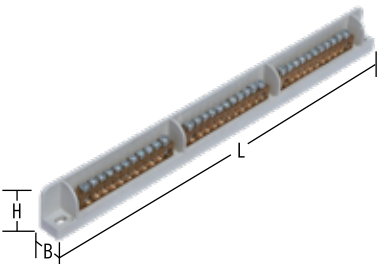

Kod / Code	Ürün Tanımı / Product Name	L	B	H	Koli Adedi / Box Qty.	Birim Fiyat / Unit Price (Adet/pcs)
İRTU-TKG30011	3x11 DELİK ÜÇ KUTUP (6,5x9 mm) / 3x11 HOLE THREE POLE (6,5x9 mm)	260	245	25.65	100	219,45 TL
İRTU-TKG31011	3x11 DELİK ÜÇ KUTUP (7x12 mm) / 3x11 HOLE THREE POLE (7x12 mm)	260	245	25.65	100	296,00 TL

Ayaklı Pano Topraklama Klemensleri 63A (6x8 mm)
Panel Grounding Terminals with Plastic Foot 63A (6x8 mm)

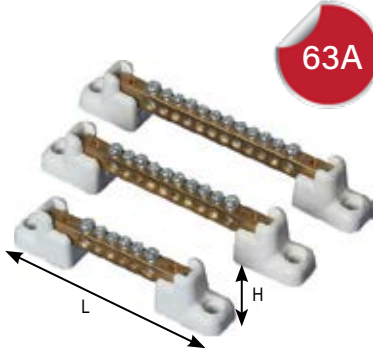

63A

Kod / Code	Ürün Tanımı / Product Name	L	H	Koli Ad. / Box Qty.	Birim Fiyat / Unit Price (Adet/pcs)
İRTU-TKA8006	6 DELİKLİ A.TOP. KLM. / 6 PERFORATED TERMINAL WITH FOOT	85	21	100	51,00 TL
İRTU-TKA8007	7 DELİKLİ A.TOP. KLM. / 7 PERFORATED TERMINAL WITH FOOT	90	21	90	57,00 TL
İRTU-TKA8010	10 DELİKLİ A.TOP. KLM. / 10 PERFORATED TERMINAL WITH FOOT	108	21	80	67,50 TL
İRTU-TKA8012	12 DELİKLİ A.TOP. KLM. / 12 PERFORATED TERMINAL WITH FOOT	120	21	70	72,75 TL
İRTU-TKA8015	15 DELİKLİ A.TOP. KLM. / 15 PERFORATED TERMINAL WITH FOOT	138	21	70	87,00 TL
İRTU-TKA8020	20 DELİKLİ A.TOP. KLM. / 20 PERFORATED TERMINAL WITH FOOT	165	21	50	115,50 TL
İRTU-TKA8022	22 DELİKLİ A.TOP. KLM. / 22 PERFORATED TERMINAL WITH FOOT	177	21	50	120,50 TL
İRTU-TKA8025	25 DELİKLİ A.TOP. KLM. / 25 PERFORATED TERMINAL WITH FOOT	190	21	50	135,50 TL
İRTU-TKA8030	30 DELİKLİ A.TOP. KLM. / 30 PERFORATED TERMINAL WITH FOOT	220	21	50	155,50 TL

Ayaklı Pano Topraklama Klemensleri 80A (6,5x9 mm)
Panel Grounding Terminals with Plastic Foot 80A (6,5x9 mm)

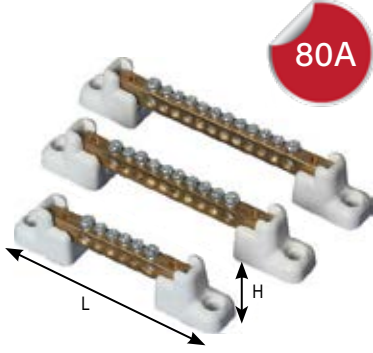

80A

Kod / Code	Ürün Tanımı / Product Name	L	H	Koli Ad. / Box Qty.	Birim Fiyat / Unit Price (Adet/pcs)
İRTU-TKA9006	6 DELİKLİ A.TOP. KLM. / 6 PERFORATED TERMINAL WITH FOOT	87	22	100	47,50 TL
İRTU-TKA9007	7 DELİKLİ A.TOP. KLM. / 7 PERFORATED TERMINAL WITH FOOT	94	22	90	52,50 TL
İRTU-TKA9010	10 DELİKLİ A.TOP. KLM. / 10 PERFORATED TERMINAL WITH FOOT	106	22	80	62,00 TL
İRTU-TKA9012	12 DELİKLİ A.TOP. KLM. / 12 PERFORATED TERMINAL WITH FOOT	124	22	70	67,50 TL
İRTU-TKA9015	15 DELİKLİ A.TOP. KLM. / 15 PERFORATED TERMINAL WITH FOOT	141	22	70	81,90 TL
İRTU-TKA9020	20 DELİKLİ A.TOP. KLM. / 20 PERFORATED TERMINAL WITH FOOT	168	22	50	106,25 TL
İRTU-TKA9022	22 DELİKLİ A.TOP. KLM. / 22 PERFORATED TERMINAL WITH FOOT	181	22	50	131,25 TL
İRTU-TKA9025	25 DELİKLİ A.TOP. KLM. / 25 PERFORATED TERMINAL WITH FOOT	196	22	50	143,75 TL
İRTU-TKA9030	30 DELİKLİ A.TOP. KLM. / 30 PERFORATED TERMINAL WITH FOOT	231	22	50	200,00 TL

Ayaklı Pano Topraklama Klemensleri 125A (7x12 mm)
Panel Grounding Terminals with Plastic Foot 125A (7x12 mm)

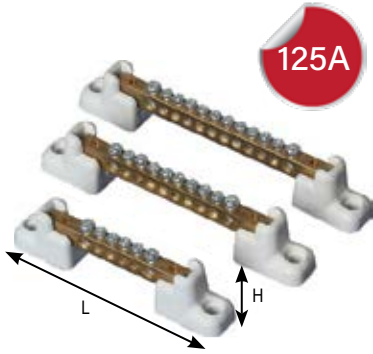

125A

Kod / Code	Ürün Tanımı / Product Name	L	H	Koli Ad. / Box Qty.	Birim Fiyat / Unit Price (Adet/pcs)
İRTU-TKA1206	6 DELİKLİ A.TOP. KLM. / 6 PERFORATED TERMINAL WITH FOOT	91	22	150	66,25 TL
İRTU-TKA1207	7 DELİKLİ A.TOP. KLM. / 7 PERFORATED TERMINAL WITH FOOT	98	22	150	67,50 TL
İRTU-TKA1210	10 DELİKLİ A.TOP. KLM. / 10 PERFORATED TERMINAL WITH FOOT	120	22	100	81,25 TL
İRTU-TKA1212	12 DELİKLİ A.TOP. KLM. / 12 PERFORATED TERMINAL WITH FOOT	137	22	100	95,00 TL
İRTU-TKA1215	15 DELİKLİ A.TOP. KLM. / 15 PERFORATED TERMINAL WITH FOOT	156	22	100	125,00 TL
İRTU-TKA1220	20 DELİKLİ A.TOP. KLM. / 20 PERFORATED TERMINAL WITH FOOT	186	22	100	150,00 TL
İRTU-TKA1225	25 DELİKLİ A.TOP. KLM. / 25 PERFORATED TERMINAL WITH FOOT	226	22	80	200,00 TL
İRTU-TKA1230	30 DELİKLİ A.TOP. KLM. / 30 PERFORATED TERMINAL WITH FOOT	266	22	75	275,00 TL

Ayaklı Pano Topraklama Klemensleri 160A (10x15 mm)
Panel Grounding Terminals with Plastic Foot 160A (10x15 mm)

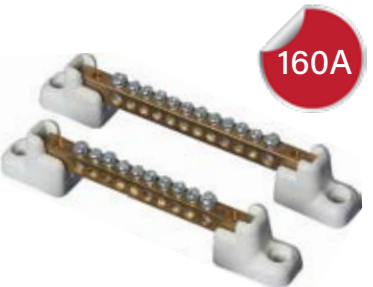

160A

Kod / Code	Ürün Tanımı / Product Name	L	H	Koli Ad. / Box Qty.	Birim Fiyat / Unit Price (Adet/pcs)
İRTU-TKA1507	7 DELİKLİ TOP. KLEMENSİ / 7 PERFORATED TERMINAL	110	30	100	207,00 TL
İRTU-TKA1510	10 DELİKLİ TOP. KLEMENSİ / 10 PERFORATED TERMINAL	145	30	100	356,50 TL
İRTU-TKA1512	12 DELİKLİ TOP. KLEMENSİ / 12 PERFORATED TERMINAL	172	30	75	425,50 TL
İRTU-TKA1515	15 DELİKLİ TOP. KLEMENSİ / 15 PERFORATED TERMINAL	199	30	50	540,50 TL
İRTU-TKA1520	20 DELİKLİ TOP. KLEMENSİ / 20 PERFORATED TERMINAL	225	30	50	695,00 TL

Tek Montaj Pano Topraklama Klemensleri 63A (6x8 mm)
Single Installations Panel Grounding Terminals 63A (6x8 mm)

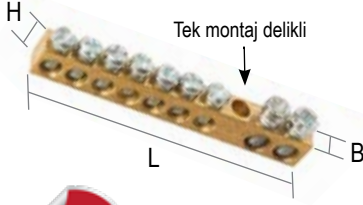

63A

Kod / Code	Ürün Tanımı / Product Name	L	B	H	Koli Ad. Box Qty.	Birim Fiyat / Unit Price (Adet/pcs)
İRTU-TK6804	4 DELİKLİ TOP. KLEMENSİ / 4 PERFORATED TERMINAL	33	6	8	1500	24,00 TL
İRTU-TK6805	5 DELİKLİ TOP. KLEMENSİ / 5 PERFORATED TERMINAL	38	6	8	1250	27,00 TL
İRTU-TK6806	6 DELİKLİ TOP. KLEMENSİ / 6 PERFORATED TERMINAL	45	6	8	1000	32,25 TL
İRTU-TK6807	7 DELİKLİ TOP. KLEMENSİ / 7 PERFORATED TERMINAL	50	6	8	1000	35,25 TL
İRTU-TK6809	9 DELİKLİ TOP. KLEMENSİ / 9 PERFORATED TERMINAL	62	6	8	750	40,50 TL
İRTU-TK6810	10 DELİKLİ TOP. KLEMENSİ / 10 PERFORATED TERMINAL	68	6	8	750	49,50 TL
İRTU-TK6812	12 DELİKLİ TOP. KLEMENSİ / 12 PERFORATED TERMINAL	80	6	8	500	60,00 TL

Ayaksız Pano Topraklama Klemensleri 63A (6x8 mm)
Panel Grounding Terminals without Plastic Foot 63A (6x8 mm)



63A

Kod / Code	Ürün Tanımı / Product Name	L	B	H	Koli Ad. Box Qty.	Birim Fiyat / Unit Price (Adet/pcs)
İRTU-TK8006	6 DELİKLİ TOP. KLEMENSİ / 6 PERFORATED TERMINAL	52	6	8	500	48,00 TL
İRTU-TK8007	7 DELİKLİ TOP. KLEMENSİ / 7 PERFORATED TERMINAL	57	6	8	500	54,00 TL
İRTU-TK8010	10 DELİKLİ TOP. KLEMENSİ / 10 PERFORATED TERMINAL	76	6	8	400	64,50 TL
İRTU-TK8012	12 DELİKLİ TOP. KLEMENSİ / 12 PERFORATED TERMINAL	88	6	8	400	70,50 TL
İRTU-TK8015	15 DELİKLİ TOP. KLEMENSİ / 15 PERFORATED TERMINAL	105	6	8	250	84,00 TL
İRTU-TK8020	20 DELİKLİ TOP. KLEMENSİ / 20 PERFORATED TERMINAL	134	6	8	250	112,50 TL
İRTU-TK8022	22 DELİKLİ TOP. KLEMENSİ / 22 PERFORATED TERMINAL	146	6	8	250	118,50 TL

Tek Montaj Pano Topraklama Klemensleri 80A (6,5x9 mm)
Single Installations Panel Grounding Terminals 80A (6,5x9 mm)



80A

Kod / Code	Ürün Tanımı / Product Name	L	B	H	Koli Ad. Box Qty.	Birim Fiyat / Unit Price (Adet/pcs)
İRTU-TK9004	4 DELİKLİ TOP. KLEMENSİ / 4 PERFORATED TERMINAL	33	9	6,5	1500	33,00 TL
İRTU-TK9005	5 DELİKLİ TOP. KLEMENSİ / 5 PERFORATED TERMINAL	38	9	6,5	1250	37,10 TL
İRTU-TK9006	6 DELİKLİ TOP. KLEMENSİ / 6 PERFORATED TERMINAL	45	9	6,5	1000	40,85 TL
İRTU-TK9007	7 DELİKLİ TOP. KLEMENSİ / 7 PERFORATED TERMINAL	50	9	6,5	1000	45,30 TL
İRTU-TK9009	9 DELİKLİ TOP. KLEMENSİ / 9 PERFORATED TERMINAL	62	9	6,5	750	51,00 TL
İRTU-TK9010	10 DELİKLİ TOP. KLEMENSİ / 10 PERFORATED TERMINAL	68	9	6,5	750	53,00 TL
İRTU-TK9012	12 DELİKLİ TOP. KLEMENSİ / 12 PERFORATED TERMINAL	80	9	6,5	500	57,40 TL

Ayaksız Pano Topraklama Klemensleri 80A (6,5x9 mm)
Panel Grounding Terminals without Plastic Foot 80A (6,5x9 mm)



80A

Kod / Code	Ürün Tanımı / Product Name	L	B	H	Koli Ad. Box Qty.	Birim Fiyat / Unit Price (Adet/pcs)
İRTU-TK0006	6 DELİKLİ TOP. KLEMENSİ / 6 PERFORATED TERMINAL	62	9	6,5	500	44,40 TL
İRTU-TK0007	7 DELİKLİ TOP. KLEMENSİ / 7 PERFORATED TERMINAL	69	9	6,5	500	49,20 TL
İRTU-TK0010	10 DELİKLİ TOP. KLEMENSİ / 10 PERFORATED TERMINAL	83	9	6,5	400	57,60 TL
İRTU-TK0012	12 DELİKLİ TOP. KLEMENSİ / 12 PERFORATED TERMINAL	99	9	6,5	400	62,40 TL
İRTU-TK0015	15 DELİKLİ TOP. KLEMENSİ / 15 PERFORATED TERMINAL	116	9	6,5	250	75,60 TL
İRTU-TK0020	20 DELİKLİ TOP. KLEMENSİ / 20 PERFORATED TERMINAL	143	9	6,5	250	99,60 TL
İRTU-TK0022	22 DELİKLİ TOP. KLEMENSİ / 22 PERFORATED TERMINAL	156	9	6,5	250	123,60 TL
İRTU-TK0025	25 DELİKLİ TOP. KLEMENSİ / 25 PERFORATED TERMINAL	173	9	6,5	100	135,60 TL
İRTU-TK0030	30 DELİKLİ TOP. KLEMENSİ / 30 PERFORATED TERMINAL	206	9	6,5	100	199,80 TL

Ayaksız Pano Topraklama Klemensleri 125A (7x12 mm)
Panel Grounding Terminals without Plastic Foot 125A (7x12 mm)



125A

Kod / Code	Ürün Tanımı / Product Name	L1	L2	B	H	Koli Ad. Box Qty.	Birim Fiyat / Unit Price (Adet/pcs)
İRTU-TK1206	6 DELİKLİ TOP. KLEMENSİ / 6 PERFORATED TERMINAL	69	55	7	12	150	63,60 TL
İRTU-TK1207	7 DELİKLİ TOP. KLEMENSİ / 7 PERFORATED TERMINAL	76	62	7	12	150	64,80 TL
İRTU-TK1210	10 DELİKLİ TOP. KLEMENSİ / 10 PERFORATED TERMINAL	98	84	7	12	100	78,00 TL
İRTU-TK1212	12 DELİKLİ TOP. KLEMENSİ / 12 PERFORATED TERMINAL	115	101	7	12	100	91,20 TL
İRTU-TK1215	15 DELİKLİ TOP. KLEMENSİ / 15 PERFORATED TERMINAL	134	120	7	12	100	120,00 TL
İRTU-TK1220	20 DELİKLİ TOP. KLEMENSİ / 20 PERFORATED TERMINAL	164	150	7	12	100	144,00 TL
İRTU-TK1225	25 DELİKLİ TOP. KLEMENSİ / 25 PERFORATED TERMINAL	204	190	7	12	80	192,00 TL
İRTU-TK1230	30 DELİKLİ TOP. KLEMENSİ / 30 PERFORATED TERMINAL	244	230	7	12	75	264,00 TL

Ayaksız Pano Topraklama Klemensleri 160A (10x15 mm)
Panel Grounding Terminals without Plastic Foot 160A (10x15 mm)

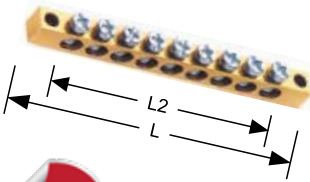

160A

Kod / Code	Ürün Tanımı / Product Name	L1	L2	Koli Ad. Box Qty.	Birim Fiyat / Unit Price (Adet/pcs)
İRTU-TK1507	7 DELİKLİ TOP. KLEMENSİ / 7 PERFORATED TERMINAL	100	90	100	315,00 TL
İRTU-TK1510	10 DELİKLİ TOP. KLEMENSİ / 10 PERFORATED TERMINAL	135	124	100	352,50 TL
İRTU-TK1512	12 DELİKLİ TOP. KLEMENSİ / 12 PERFORATED TERMINAL	157	147	75	420,00 TL
İRTU-TK1515	15 DELİKLİ TOP. KLEMENSİ / 15 PERFORATED TERMINAL	190	180	50	570,00 TL
İRTU-TK1520	20 DELİKLİ TOP. KLEMENSİ / 20 PERFORATED TERMINAL	265	255	50	720,00 TL

Topraklama Barası Copper Ground Busbar

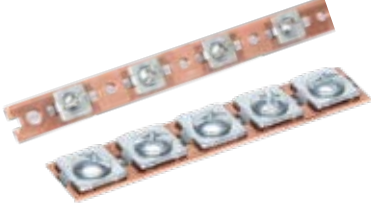

Kod / Code	Vida Sayısı / Count of Screw	Bakır Kalınlığı / Copper Thickness	Uzunluk / Length (mt)	Paket Miktarı / Box Qty	Birim Fiyat / Unit Price (Adet/pcs)
İRTU-TB3115	31	1,5 x 15,0	1	10	
İRTU-TB6115	61	1,5 x 15,0	1	10	
İRTU-TB3120	31	2,0 x 15,0	1	10	
İRTU-TB6120	61	2,0 x 15,0	1	10	
İRTU-TB3130	31	3,0 x 15,0	1	10	
İRTU-TB6130	61	3,0 x 15,0	1	10	

Vidalı Bara Mesnedi Terminal Blocks Support Bracket



Kod / Code	Cinsi / Type	Paket Miktarı / Box Qty	Birim Fiyat / Unit Price (Adet/pcs)
İRTU-KBM1001	Kumanda Bara Mesnedi / Screwed Busbar Support	500	15,00 TL

Plastik Ayaklı Bakır Topraklama Barası (4x20 mm) Copper Panel Grounding Terminal With Plastic Foot (4x20mm)

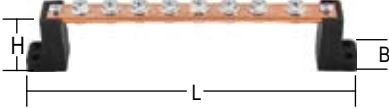

Kod / Code	Ürün Tanımı / Product Name	L	B	H	Koli Ad. Box Qty.	Birim Fiyat / Unit Price (Adet/pcs)
İRTU-205220	1 Giriş 7 Çıkış / 1 Input 7 Output	220	40	39	100	693,00 TL
İRTU-205270	1 Giriş 10 Çıkış / 1 Input 10 Output	270	40	39	75	866,00 TL
İRTU-205345	1 Giriş 14 Çıkış / 1 Input 14 Output	345	40	39	50	1.105,00 TL

Eş Potansiyel Bara Copper Ground Bar Kit



Bara setine civata dahil değildir

Kod / Code	Ürün Tanımı / Product Name	Kutu Adedi / Box Qty.	Birim Fiyat / Unit Price (Adet/pcs)
İRTU-303250	30 x 3 25 cm 7 Delik / 30 x 3 25 cm 7 Hole	1	
İRTU-303300	30 x 3 30 cm 10 Delik / 30 x 3 30 cm 10 Hole	1	
İRTU-305300	30 x 5 30 cm 7 Delik / 30 x 5 30 cm 7 Hole	1	
İRTU-305400	30 x 5 40 cm 9 Delik / 30 x 5 40 cm 9 Hole	1	
İRTU-305500	30 x 5 50 cm 12 DELİK / 30 x 5 50 cm 12 Hole	1	

Bakır Bağlantı Klemensi
Copper Connection Terminal

Kod / Code	Ürün Tanımı / Product Name	L	B	H	Koli Ad. Box Qty.	Birim Fiyat / Unit Price (Adet/pcs)
İRTU-GDB4010	4x1-Tekli Güç Dağıtım Barası (125A) / Power Distribution Busbar (125A)	120	20	19	50	
İRTU-GDB2010	2x1-İki Kutuplu Güç Dağıtım Barası (125A) / Power Distribution Busbar (125A)	120	20	19	50	
İRTU-GDB3010	3x1 Tekli Güç Dağıtım Barası (400A) / Power Distribution Busbar (400A)	200	39	34	50	

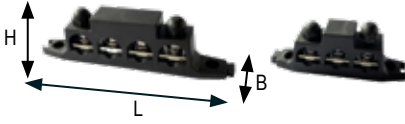
Bakır Bağlantı Klemensi
Copper Connection Terminal

Kod / Code	Ürün Tanımı / Product Name	L	B	H	Koli Ad. Box Qty.	Birim Fiyat / Unit Price (Adet/pcs)
İRTU-GDB4011	4x1 Tekli Dağıtım Barası (300A) (Kapaklı)	195	28,5	52	50	
İRTU-GDB3011	3x1 Tekli Dağıtım Barası (300A) (Kapaklı)	146	28,5	52	50	

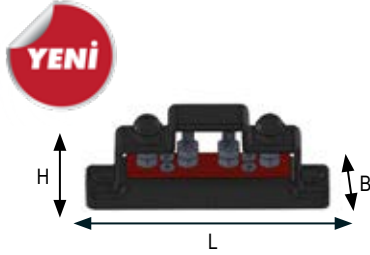
Bakır Bağlantı Klemensi
Copper Connection Terminal

Kod / Code	Ürün Tanımı / Product Name	L	B	H	Koli Ad. Box Qty.	Birim Fiyat / Unit Price (Adet/pcs)
İRTU-GDB4012	4x1-Tekli Güç Dağıtım Barası M6 (220A) / Connection Busbar M6 (220A)	116	23	48	50	
İRTU-GDB3012	3x1-Tekli Bağlantı Klemensi M8 (300A) / Connection Busbar M8 (300A)	103,5	28	49	50	

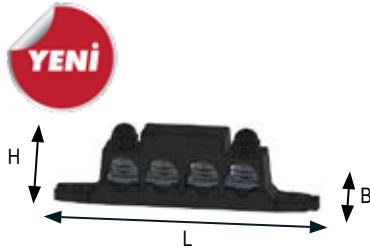
Bakır Bağlantı Klemensi
Copper Connection Terminal

Kod / Code	Ürün Tanımı / Product Name	L	B	H	Koli Ad. Box Qty.	Birim Fiyat / Unit Price (Adet/pcs)
İRTU-GDB2011	2x1 Çift Kutuplu Dağıtım Barası (300A) (Kapaklı)	194,40	28	49	50	

Bakır Bağlantı Klemensi
Copper Connection Terminal

Kod / Code	Ürün Tanımı / Product Name	L	B	H	Koli Ad. Box Qty.	Birim Fiyat / Unit Price (Adet/pcs)
İRTU-GDB2012	2x1 Çift Kutuplu Dağıtım Barası (300A) (Kapaklı)	116	23	44	50	

Geçmeli Bakır Bara Bağlantı Klemensi (Paletli Sistem) Interfaced Busbar Connection Terminal (Track System)

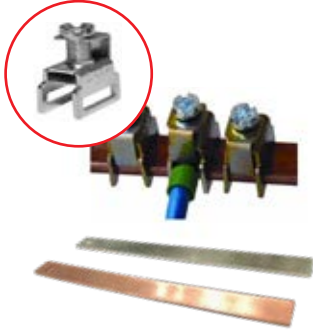

Kod / Code	Ürün Tanımı / Product Name	Kutu Adedi / Box Qty	Birim Fiyat / Unit Price (Adet/pcs)
İRTU-2159	SK12 F3 Bakır Bara Klemensi 4 mm ² / Copper Terminal	500	18,45 TL
İRTU-2160	SK12 F3 Bakır Bara Klemensi 16 mm ² / Copper Terminal	300	
İRTU-2161	SK12 F3 Bakır Bara Klemensi 35 mm ² / Copper Terminal	250	
İRTU-2162	12 x 3 mm Elektrolitik Bakır Bara 1 mt / Electrolytic Copper Busbar	1 Mt	

Bakır Bara Bağlantı Klemensi (Yay Baskılı) Busbar Connection Terminal (Spring System)



Kod / Code	Kesit / Cros Section	Ürün Tanımı / Product Name	Kutu Adedi / Box Qty	Birim Fiyat / Unit Price (Adet/pcs)
İRTU-2140	16 mm ²	SK16F5 Bakır Bara Klemensi 1,5-16 mm ² / Copper Terminal	100	
İRTU-2142	35 mm ²	SK35F5 Bakır Bara Klemensi 1,5-35 mm ² / Copper Terminal	100	
İRTU-2144	70 mm ²	SK70F5 Bakır Bara Klemensi 16-70 mm ² / Copper Terminal	25	
İRTU-2146	120 mm ²	SK120F5 Bakır Bara Klemensi 16-120 mm ² / Copper Terminal	25	

U Klemensler U Type Terminal Blocks



U Klemens plastik kapağı dahildir.

Kod / Code	Ürün Tanımı / Product Name	Kutu Adedi / Box Qty.	Birim Fiyat / Unit Price (Adet/pcs)
İRTU-7050	6'lık U Klemens	300	69,10 TL
İRTU-7051	10'lük U Klemens	250	84,85 TL
İRTU-7052	16'lık U Klemens	150	106,00 TL
İRTU-7053	25'lik U Klemens	100	120,80 TL
İRTU-7054	35'lik U Klemens	75	147,00 TL
İRTU-7055	50'lik U Klemens	50	225,80 TL
İRTU-7056	70'lik U Klemens	40	245,70 TL
İRTU-7057	95'lik U Klemens	30	338,00 TL
İRTU-7058	120'lik U Klemens	20	352,20 TL
İRTU-7059	150'lik U Klemens	10	478,40 TL
İRTU-7060	U Klemens Kayığı	100	

Tırnaklı Klemensler Clawed Clamps



Kod / Code	Ürün Tanımı / Product Name	Kutu Adedi / Box Qty.	Birim Fiyat / Unit Price (Adet/pcs)
İRTU-7070	No. 1 16 mm ²	500	
İRTU-7071	No. 2 25 mm ²	250	
İRTU-7072	No. 3 35 mm ²	100	
İRTU-7073	No. 4 50 mm ²	100	
İRTU-7074	No. 5 70 mm ²	100	
İRTU-7075	No. 6-7 120 mm ²	50	

Trifaze Müşterek Bara
Three Phases Insulated Busbar Pin Type

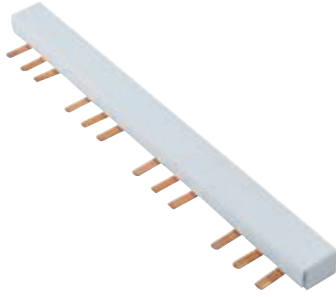

3056



5533

Kod / Code	Faz / Phase	Modül Sayısı Module Number	Bakır Kalınlığı Copper Thickness	Kutu Adedi Box Qty	Birim Fiyat Unit Pr. (adet/pcs)
İRTU-3041	3 FAZ	4	1,0 mm / 80A	30	
İRTU-3042	3 FAZ	6	1,0 mm / 80A	30	
İRTU-3043	3 FAZ	8	1,0 mm / 80A	30	
İRTU-3044	3 FAZ	10	1,0 mm / 80A	30	
İRTU-3045	3 FAZ	20	1,0 mm / 80A	25	
İRTU-3051	3 FAZ	4	1,5 mm / 100A	30	
İRTU-3052	3 FAZ	6	1,5 mm / 100A	30	
İRTU-3053	3 FAZ	8	1,5 mm / 100A	30	
İRTU-3054	3 FAZ	10	1,5 mm / 100A	30	
İRTU-3055	3 FAZ	20	1,5 mm / 100A	25	
İRTU-3066	3 FAZ	4	2,0 mm / 125A	30	
İRTU-3067	3 FAZ	6	2,0 mm / 125A	30	
İRTU-3068	3 FAZ	8	2,0 mm / 125A	30	
İRTU-3069	3 FAZ	10	2,0 mm / 125A	30	
İRTU-3070	3 FAZ	20	2,0 mm / 125A	25	
İRTU-3056	TRİFAZE BARA YAN KAPAK (1,5 mm)			100	
İRTU-5833	TRİFAZE BARA YAN KAPAK (1 mm)			100	

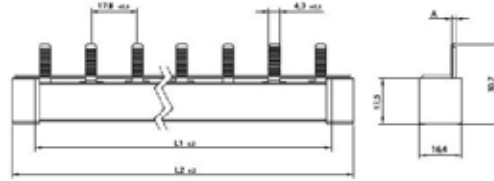

3 Faz + Nötr Müşterek W Otomat Bara
3 Phase + Neutral Joint W Automat Bar

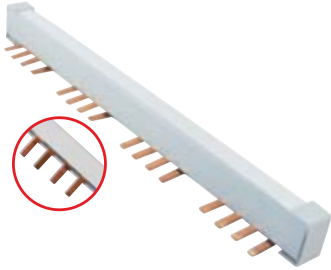

3057

Kod / Code	Faz / Phase	Modül Sayısı Module Number	Bakır Kalınlığı Copper Thickness	Kutu Adedi Box Qty	Birim Fiyat Unit Pr. (adet/pcs)
İRTU-3058	3 Faz + Nötr / 3 Phase + Neutral	4	1,5 mm	16	
İRTU-3059	3 Faz + Nötr / 3 Phase + Neutral	8	1,5 mm	16	
İRTU-3060	3 Faz + Nötr / 3 Phase + Neutral	14	1,5 mm	16	
İRTU-3057	Yan Kapak / Side Cover			100	

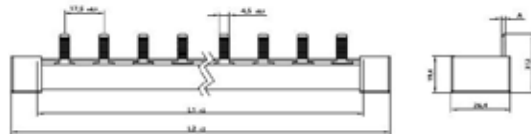

Müşterek W Otomat Bara (L1+N, L2+N, L3+N)
Joint W Automat Bar (L1+N, L2+N, L3+N)

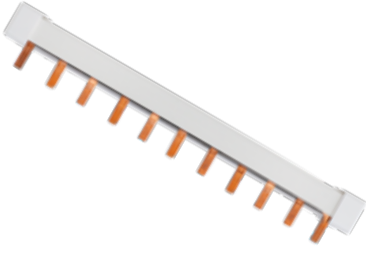

FTG-A2

Kod / Code	Faz / Phase	Modül Sayısı Module Number	Kutu Adedi Box Qty	Birim Fiyat Unit Pr. (adet/pcs)
FTG-4ES16L54AOAON-01	L1 + H, L2 + N, L3 + N..	13 Modül 1 M	1	
FTG-A2	Yan Kapak / Side Cover		1	

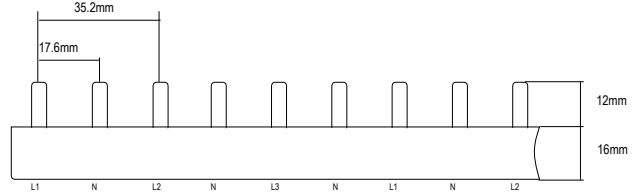
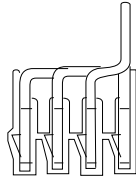

İzolasyonlu Motor Koruma Baraları
Insulated Engine Protection Bars



Kod / Code	Faz / Phase	Adım Genişliği Step Width	Kutu Adedi Box Qty	Birim Fiyat Unit Pr. (adet/pcs)
İRTU-MSVG54-14-2	İkili Modül / Dual Module	45 + 9 = 54 mm	1	
İRTU-MSVG54-14-4	Dört Modül / Four Module	45 + 9 = 54 mm	1	
İRTU-MSVG54-14-5	Beş Modül / Five Module	45 + 9 = 54 mm	1	
İRTU-MSVG45-14-3	Üç Modül / Three Module	45 mm	1	
İRTU-MSVG45-14-4	Dört Modül / Four Module	45 mm	1	



3061



3065



802/115S



802/215S



802/114



GE1-14

W Otomat Bara Bağlantı Klemensi
Modular Power Terminal

Kod / Code	Cinsi / Type	Kutu Adedi Box Qty	Birim Fiyat Unit Pr. (adet/pcs)
İRTU-3061	No: 1 (2,5 - 10 mm ²)	150	
İRTU-3065	No: 2 (16 - 25 mm ²)	100	
POLL-2010201	No: 2 (6 - 25 mm ²)	30	
POLL-2010235	No: 3 (6 - 50 mm ²)	25	
FTG-802/215 S	No: 2 (6 - 25 mm ²) Çatal Uçlu / Fork Type	25	
FTG-MSV GE 1-14	No.2 (6-25 mm ²) Çatal Uçlu, Üçlü (L1, L2, L3) / Fork Type Triple	1	

AKSESUARLAR

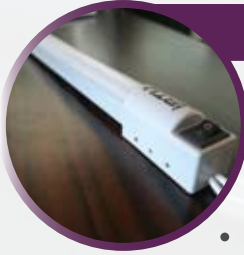

PANO İÇİ AYDINLATMA

- Standart Led Aydınlatma.
- Mıknatıslı Led Aydınlatma.
- Sensörlü Led Aydınlatma.
- 220V Led Aydınlatma.
- 12-24 Volt Led Aydınlatma.



SİNYAL VE BUTON GRUBU

- Ø22 Led Sinyaller.
- Işıklı ve Yaylı Butonlar.
- Acil Stop Mantar Butonlar.
- İkiz Butonlar.
- Mandal Butonlar.



PANO ETİKETLERİ

- Otomat Altı Etiketler.
- Pano Sinyal Etiketleri.
- Pano Uyarı Etiketleri.
- Pvc ve Sac Uyarı Etiketleri.
- Pano İçi Kutu Etiketler.



PLASTİK APARATLAR

- Proje Cepleri
- Havalandırma Filtreleri.
- Pano Havalandırma Aparatı.
- Direnaj Tapası.



MARKALAMA SİSTEMLERİ

- Komponent Etiketler.
- Kablolama Çözümleri.
- İnce ve Kalın Pano Etiketleri.
- Klemensler İçin Markala Sistemleri.



PANO APARATLARI

- Pano Prileri.
- Monofaze Kapaklı Prizler.
- 15 - 45 - 100 -150W Termostatlar.
- Isıtma ve Soğutma Termostatları.



SAC AKSESUARLARI

- Makina Kapak Grupları.
- Pano Perde Civatası.
- Plastik Cam Tutucu.
- Pano Köşe Aparatı.
- Sürgülü Kilitler.



Gövde Montajlı 22030/E

Kısa Gövde 22030/ES

STANDART LED AYDINLATMA

STANDARD LED LIGHTING

220 / 240 Volt Led Aydınlatma
220 / 240 Voltage Led Panel Lighting

Kod / Code	Ürün Tanımı / Product Name	Volt / Voltage	L (mm)	H (mm)	Birim Fiyat (Standart)
İRTU-LED 22030-E	30 cm Plastik Gövde Ekonomik / 30 cm Plastic Body Eco	220 Volt	300	23	9,60 \$
İRTU-LED 22030-ES	30 cm Alüminyum Gövde Ekonomik / 30 cm Aluminium Body Eco	220 Volt	300	23	11,00 \$

Kod / Code	Ürün Tanımı / Product Name	Volt / Voltage	L (mm)	H (mm)	Birim Fiyat (Standart)
İRTU-LED 22025	25 cm Led Pano Aydınlatması / 25 cm Led Panel Lighting	220 Volt	250	23	16,50 \$
İRTU-LED 22030	30 cm Led Pano Aydınlatması / 30 cm Led Panel Lighting	220 Volt	300	23	17,20 \$
İRTU-LED 22035	35 cm Led Pano Aydınlatması / 35 cm Led Panel Lighting	220 Volt	350	23	18,95 \$
İRTU-LED 22045	45 cm Led Pano Aydınlatması / 45 cm Led Panel Lighting	220 Volt	450	23	20,80 \$
İRTU-LED 22060	60 cm Led Pano Aydınlatması / 60 cm Led Panel Lighting	220 Volt	600	23	25,05 \$
Voltaj : 110/220 V AC		Güç : 5 W	IP : 20	Frekans : 50/60 Hz.	Renk : Beyaz

12 Volt Led Aydınlatma
12 Voltage Led Panel Lighting

Kod / Code	Ürün Tanımı / Product Name	Volt / Voltage	L (mm)	H (mm)	Birim Fiyat (Standart)
İRTU-LED 12025	25 cm Led Pano Aydınlatması / 25 cm Led Panel Lighting	12 Volt	250	23	15,05 \$
İRTU-LED 12030	30 cm Led Pano Aydınlatması / 30 cm Led Panel Lighting	12 Volt	300	23	15,80 \$
İRTU-LED 12045	45 cm Led Pano Aydınlatması / 45 cm Led Panel Lighting	12 Volt	450	23	20,05 \$
İRTU-LED 12065	65 cm Led Pano Aydınlatması / 65 cm Led Panel Lighting	12 Volt	650	23	24,70 \$
Voltaj : 12 V DC		Renk : Beyaz	Güç : 4 W	IP : 20	

24 Volt Led Aydınlatma
24 Voltage Led Panel Lighting

Kod / Code	Ürün Tanımı / Product Name	Volt / Voltage	L (mm)	H (mm)	Birim Fiyat (Standart)
İRTU-LED 24025	25 cm Led Pano Aydınlatması / 25 cm Led Panel Lighting	24 Volt	250	23	15,05 \$
İRTU-LED 24030	30 cm Led Pano Aydınlatması / 30 cm Led Panel Lighting	24 Volt	300	23	15,80 \$
İRTU-LED 24045	45 cm Led Pano Aydınlatması / 45 cm Led Panel Lighting	24 Volt	450	23	20,05 \$
İRTU-LED 24065	65 cm Led Pano Aydınlatması / 65 cm Led Panel Lighting	24 Volt	650	23	24,70 \$
Voltaj : 24 V DC		Renk : Beyaz	Güç : 4 W	IP : 20	

- Alüminyum Gövde
Aluminum body
- Plastik Geçme Ayaklarla Kolay Montaj
Easy Installation with Plastic Feet
- Değişken Ölçülerde ve Voltajlarda Üretim İmkanı
Production Opportunity in Variable Sizes and Voltages
- Aydınlatma Led Tipi ve Farklı Renk Seçenekleri (Beyaz, Günışığı, Kırmızı, Yeşil, Mavi)
Lighting Led Type and Different Color Options (White, Daylight, Red, Green, Blue)

MIKNATISLI VE SENSÖRLÜ LED AYDINLATMA MAGNETIC AND SENSORED LED LIGHTING



Mıknatıslı



220 / 240 Volt Led Aydınlatma 220 / 240 Voltage Led Panel Lighting

Kod / Code	Ürün Tanımı / Product Name	Volt / Voltage	L (mm)	H (mm)	Birim Fiyat (Mıknatıslı)	Kod / Code	Birim Fiyat (Sensörlü)
İRTU-LED 22025/M	25 cm Led Pano Aydınlatması / 25 cm Led Panel Lighting	220 Volt	250	23	26,00 \$	İRTU-LED 22025/S	31,50 \$
İRTU-LED 22030/M	30 cm Led Pano Aydınlatması / 30 cm Led Panel Lighting	220 Volt	300	23	26,60 \$	İRTU-LED 22030/S	32,55 \$
İRTU-LED 22035/M	35 cm Led Pano Aydınlatması / 35 cm Led Panel Lighting	220 Volt	350	23	29,45 \$	İRTU-LED 22035/S	35,50 \$
İRTU-LED 22045/M	45 cm Led Pano Aydınlatması / 45 cm Led Panel Lighting	220 Volt	450	23	30,00 \$	İRTU-LED 22045/S	36,55 \$
İRTU-LED 22055/M	55 cm Led Pano Aydınlatması / 55 cm Led Panel Lighting	220 Volt	550	23	33,25 \$	İRTU-LED 22055/S	43,30 \$
İRTU-LED 22060/M	60 cm Led Pano Aydınlatması / 60 cm Led Panel Lighting	220 Volt	600	23	41,50 \$	İRTU-LED 22060/S	49,90 \$

Voltaj : 110/220 V AC Güç : 5 W IP : 20 Frekans : 50/60 Hz. Renk : Beyaz



12 Volt Led Aydınlatma 12 Voltage Led Panel Lighting

Kod / Code	Ürün Tanımı / Product Name	Volt / Voltage	L (mm)	H (mm)	Birim Fiyat (Mıknatıslı)	Kod / Code	Birim Fiyat (Sensörlü)
İRTU-LED 12025/M	25 cm Led Pano Aydınlatması / 25 cm Led Panel Lighting	12 Volt	250	23	26,00 \$	İRTU-LED 12025/S	31,50 \$
İRTU-LED 12030/M	30 cm Led Pano Aydınlatması / 30 cm Led Panel Lighting	12 Volt	300	23	26,60 \$	İRTU-LED 12030/S	32,55 \$
İRTU-LED 12035/M	35 cm Led Pano Aydınlatması / 35 cm Led Panel Lighting	12 Volt	350	23	29,45 \$	İRTU-LED 12035/S	35,50 \$
İRTU-LED 12045/M	45 cm Led Pano Aydınlatması / 45 cm Led Panel Lighting	12 Volt	450	23	30,00 \$	İRTU-LED 12045/S	36,55 \$
İRTU-LED 12055/M	55 cm Led Pano Aydınlatması / 55 cm Led Panel Lighting	12 Volt	550	23	33,25 \$	İRTU-LED 12055/S	43,30 \$
İRTU-LED 12065/M	65 cm Led Pano Aydınlatması / 65 cm Led Panel Lighting	12 Volt	650	23	41,50 \$	İRTU-LED 12065/S	49,90 \$

Voltaj : 12 V DC Renk : Beyaz Güç : 4 W IP : 20



24 Volt Led Aydınlatma 24 Voltage Led Panel Lighting

Kod / Code	Ürün Tanımı / Product Name	Volt / Voltage	L (mm)	H (mm)	Birim Fiyat (Mıknatıslı)	Kod / Code	Birim Fiyat (Sensörlü)
İRTU-LED 24025/M	25 cm Led Pano Aydınlatması / 25 cm Led Panel Lighting	24 Volt	250	23	26,00 \$	İRTU-LED 24025/S	31,50 \$
İRTU-LED 24030/M	30 cm Led Pano Aydınlatması / 30 cm Led Panel Lighting	24 Volt	300	23	26,60 \$	İRTU-LED 24030/S	32,55 \$
İRTU-LED 24035/M	35 cm Led Pano Aydınlatması / 35 cm Led Panel Lighting	24 Volt	350	23	29,45 \$	İRTU-LED 24035/S	35,50 \$
İRTU-LED 24045/M	45 cm Led Pano Aydınlatması / 45 cm Led Panel Lighting	24 Volt	450	23	30,00 \$	İRTU-LED 24045/S	36,55 \$
İRTU-LED 24055/M	55 cm Led Pano Aydınlatması / 55 cm Led Panel Lighting	24 Volt	550	23	33,25 \$	İRTU-LED 24055/S	43,30 \$
İRTU-LED 24065/M	65 cm Led Pano Aydınlatması / 65 cm Led Panel Lighting	24 Volt	650	23	41,50 \$	İRTU-LED 24065/S	49,90 \$

Voltaj : 24 V DC Renk : Beyaz Güç : 4 W IP : 20



Ø22 Led Sinyal Lambası Led Pilot Light



Kod / Code	Ürün Tanımı / Product Name	Renk / Color	Birim Fiyat Unit Price (adet / pcs)
MB3-EV 916	Led sinyal 220V AC/DC	Beyaz / White	45,10 TL
MB3-EV 936		Yeşil / Green	39,60 TL
MB3-EV 946		Kırmızı / Red	39,60 TL
MB3-EV 956		Sarı / Yellow	39,60 TL
MB3-EV 966		Mavi / Blue	45,10 TL
MB3-EV 917	Led sinyal 24V AC/DC	Beyaz / White	45,10 TL
MB3-EV 937		Yeşil / Green	39,60 TL
MB3-EV 947		Kırmızı / Red	39,60 TL
MB3-EV 957		Sarı / Yellow	39,60 TL
MB3-EV 967		Mavi / Blue	45,10 TL
MB3-EV 918	Led sinyal 110V AC/DC	Beyaz / White	45,10 TL
MB3-EV 938		Yeşil / Green	39,60 TL
MB3-EV 948		Kırmızı / Red	39,60 TL
MB3-EV 958		Sarı / Yellow	39,60 TL
MB3-EV 968		Mavi / Blue	45,10 TL

Işıklı Yaylı Butonlar 220VAC 3A/250VAC/ Illuminated Push Button



BA9S Neon Plastik



Led Plastik



BA9S Metal

Kod / Code	Renk / Color	Birim Fiyat Unit Price (Adt/ Pcs)
İRTU-EW 611	Beyaz / White / NO	198,00 TL
İRTU-EW 631	Yeşil / Green / NO	198,00 TL
İRTU-EW 642	Kırmızı / Red / NC	198,00 TL
İRTU-EW 651	Sarı / Yellow / NO	198,00 TL
İRTU-EW 661	Mavi / Blue / NO	198,00 TL
İRTU-EW 771	Beyaz / White / NO	198,00 TL
İRTU-EW 731	Yeşil / Green / NO	198,00 TL
İRTU-EW 742	Kırmızı / Red / NC	198,00 TL
İRTU-EW 751	Sarı / Yellow / NO	198,00 TL
İRTU-EW 761	Mavi / Blue / NO	198,00 TL
İRTU-BW 611	Beyaz / White / NO	
İRTU-BW 631	Yeşil / Green / NO	
İRTU-BW 642	Kırmızı / Red / NC	
İRTU-BW 651	Sarı / Yellow / NO	
İRTU-BW 661	Mavi / Blue / NO	

Yaylı Butonlar, 3A / 250VAC / Spring Push Button



Plastik / Plastic



Metal / Metal



Işaretli / Direction

İRTU-EA 210	Siyah / Black / NO		106,70 TL
İRTU-EA 310	Yeşil / Green / NO		106,70 TL
İRTU-EA 420	Kırmızı / Red / NC		106,70 TL
İRTU-EA 510	Sarı / Yellow / NO		106,70 TL
İRTU-EA 610	Mavi / Blue / NO		106,70 TL
İRTU-BA 210	Siyah / Black / NO		
İRTU-BA 310	Yeşil / Green / NO		
İRTU-BA 420	Kırmızı / Red / NC		
İRTU-BA 510	Sarı / Yellow / NO		
İRTU-BA 610	Mavi / Blue / NO		
İRTU-EA 112	Beyaz / White (→) / NO		132,00 TL
İRTU-EA 212	Siyah / Black (←) / NO		132,00 TL
İRTU-EA 514	Sarı Alarm / Yellow Alarm / NO		132,00 TL
İRTU-EA 613	Mavi / Blue (↔) / NO		132,00 TL

Acil Stop Mantar Butonlar, 3A / 250VAC / Emergency Stop Button



Plastik / Plastic



Metal / Metal



Yaylı / Spring

İRTU-ES 442	Bas-Çevir / Push-Turn Ø30/NC	
İRTU-ES 542	Bas-Çevir / Push-Turn Ø40/NC	143,00 TL
İRTU-ES 642	Bas-Çevir / Push-Turn Ø60/NC	
İRTU-ES 142	Anahtarlı / With Key Ø40/NC	209,00 TL
İRTU-BS 542	Bas-Çevir / Push-Turn / NC	165,00 TL
İRTU-BC 420	Yaylı / Push / NC	
İRTU-BS 142	Anahtarlı / With Key / NC	
İRTU-EC 210	Beyaz / White / NO	
İRTU-EC 310	Yeşil / Green / NO	143,00 TL
İRTU-EC 420	Kırmızı / Red / NC	143,00 TL

Ø22 Sesli Led İkaz Buzzer



İRTU-EB 164	220V Led'li	176,00 TL
İRTU-EB 174	24V Led'li	176,00 TL

İkiz Butonlar, 3A / 250VAC / Twin Button



Plastik / Plastic



Metal / Metal

İRTU-EA 845	Işıksız / Lightless / NO+NC	198,00 TL
İRTU-EW 845	Işıklı / With Light / NO+NC	275,00 TL
İRTU-BA 845	Işıksız / Lightless / NO+NC	198,00 TL
İRTU-BW 845	Işıklı / With Light / NO+NC	275,00 TL



Plastik Yaylı / Plastic Spring



Metal / Metal

Mandal Butonlar, 3A / 250VAC /

İRTU-ED 210	0-1 / NO	123,20 TL
İRTU-ED 410	0-(1) / NO	132,00 TL
İRTU-ED 330	1-0-2 / 2NO	168,30 TL
İRTU-ED 530	(1)-0-(2) / 2NO	176,00 TL
İRTU-BD 210	0-1 NO	
İRTU-BD 330	1-0-2 / 2 NO	

Otomat Altı Etiket /
Automat Label

Kod / Code	Ürün Tanımı / Product Name	Koli Adedi Box Qty. (mt)	Birim Fiyat Unit Price (mt)
İRTU-YPE20200	20 x 2000 mm YAPIŞKANLI PANO ETİKETİ / PANEL LABEL WITH STICKY	200	3,20 €
İRTU-YPE30200	30 x 2000 mm YAPIŞKANLI PANO ETİKETİ / PANEL LABEL WITH STICKY	150	3,60 €
İRTU-YPE40200	40 x 2000 mm YAPIŞKANLI PANO ETİKETİ / PANEL LABEL WITH STICKY	120	3,70 €

Kapaklı Pano Etiketi (1Mt)
Panel Label Sticky (1Mt)

Kod / Code	Ürün Tanımı / Product Name	Koli Adedi Box Qty. (ad.)	Birim Fiyat Unit Price (mt.)
İRTU-YPE7126	15 x 1000 mm YAPIŞKANLI PANO ETİKETİ / PANEL LABEL WITH STICKY	50	4,20 €
İRTU-YPE7127	15 x 2000 mm YAPIŞKANLI PANO ETİKETİ / PANEL LABEL WITH STICKY	50	4,20 €

W Otomat Örtü Aparatı (Mt) /
W Automat Cover Plate (Mt)

Kod / Code	Ürün Tanımı / Product Name	Koli Adedi / Box Qty. (mt)	Birim Fiyat Unit Price (mt)
İRTU-WCP7035	2 MT ÖRTÜ PLAKASI RAL 7035 / 2 MT COVER PLATE RAL 7035	60	3,60 €
İRTU-WCP7032	2 MT ÖRTÜ PLAKASI RAL 70352 2 MT COVER PLATE RAL 7032	60	3,60 €
İRTU-WCP9001	2 MT ÖRTÜ PLAKASI RAL 9001 / 2 MT COVER PLATE RAL 9001	60	3,60 €

W Otomat Parçalı Örtü Aparatı /
W Automat Cover Plate with Parts

Kod / Code	Ürün Tanımı / Product Name	Koli Adedi / Box Qty. (ad.)	Birim Fiyat Unit Price (ad.)
İRTU-WCPP7035	10'LU RAL 7035 / 10 PIECES RAL 7035	100	76,40 TL
İRTU-WCPP7035-E	10'LU RAL 7035 / 10 GROUPS RAL 7035 (ESNEK-MOBLEN)	100	51,50 TL
İRTU-WCPP7035-L	12-Lİ RAL 7035 / 10 GROUPS RAL 7035 (ESNEK-UYUMLU)	100	56,20 TL

Pano Etiket Ayağı
Panel Label Leg (Polyamide 6 V0)

Kod / Code	Ürün Tanımı / Product Name	Renk / Color	Koli Adedi / Box Qty.	Birim Fiyat Unit Price (adet/pcs)
İRTU-PAY1001	PLASTİK AYAK / PLASTIC LEG	RAL 7035	200	43,20 TL

Yapışkanlı Pano Etiketleri Panel Labels Adhesive

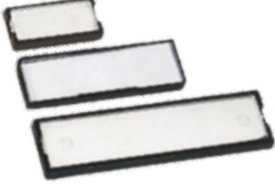

Kod / Code	Ürün Tanımı / Product Name	Koli Adedi / Box Qty.	Birim Fiyat Unit Price (Adet/pcs)
İRTU-PET3014	PANO ETİKETİ / PANEL LABEL 30 x 14mm	100	5,70 TL
İRTU-PET5214	PANO ETİKETİ / PANEL LABEL 52 x 14mm	100	6,10 TL
İRTU-PET3017	PANO ETİKETİ / PANEL LABEL 30 x 17mm	100	10,15 TL
İRTU-PET5217	PANO ETİKETİ / PANEL LABEL 52 x 17mm	100	10,80 TL
İRTU-PET7017	PANO ETİKETİ / PANEL LABEL 70 x 17mm	100	12,90 TL

Plastik Pano Sinyal Etiketi Plastic Panel Signal Label



Kod / Code	Ürün Tanımı / Product Name	Koli Adedi / Box Qty.	Birim Fiyat Unit Price (Adet/pcs)
İRTU-PSET3014	PANO SİNYAL ETİKETİ 30x14 mm / PANEL SIGNAL LABEL 30x14 mm	100	4,35 TL
İRTU-PSET3015	PANO SİNYAL ETİKETİ 27x12 mm / PANEL SIGNAL LABEL 27x12 mm	100	5,70 TL
İRTU-PSET3016	PANO SİNYAL ETİKETİ 27x18 mm / PANEL SIGNAL LABEL 27x18 mm	100	8,30 TL
İRTU-PSET3017	PANO SİNYAL ETİKETİ 27x12 mm / PANEL SIGNAL LABEL 27x12 mm	100	5,20 TL
İRTU-PSET2816	PANO SİNYAL ETİKETİ 28x16 mm / PANEL SIGNAL LABEL 28x16 mm	100	5,00 TL

Uyarı Etiketleri / Caution Labels

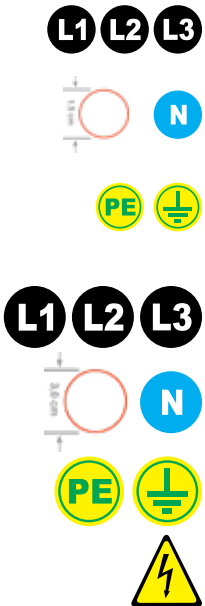

Kod / Code	Ürün Tanımı / Product Name	Poşet Ad. / Box Qty	Birim Fiyat Unit Price (Paket/Package)
İRTU-ET1001	L1-L2-L3 Bara Yapıştırma Etiketi / L1-L2-L3 Busbar Label 1,5 cm	540	240,00 TL
İRTU-ET1002	N Bara Yapıştırma Etiketi / N Busbar Label 1,5 cm	540	240,00 TL
İRTU-ET1003	Topraklama Etiketi / Grounding Label 1,5 cm	540	240,00 TL
İRTU-ET2001	L1-L2-L3 Bara Yapıştırma Etiketi / L1-L2-L3 Busbar Label 3 cm	240	240,00 TL
İRTU-ET2002	N Bara Yapıştırma Etiketi / N Busbar Label 3 cm	240	240,00 TL
İRTU-ET2003	Topraklama Etiketi / Grounding Label 3 cm	240	240,00 TL
İRTU-ET3001	Tehlike Etiketi / Danger Label 10 x 10 x 10 cm	100	950,00 TL

PVC Etiketler /
PVC Labels

Görsel / Icon	Kod / Code	Ürün Tanımı / Product Name	Koli Adedi / Box Qty.	Birim Fiyat Unit Price (Adet/pcs)
	İRTU-PVC1	14 x 20 mm 0,50 PVC Etiket Arkası Tamamen Çift Taraflı Bantlı / 14 x 20 mm 0,50 PVC Label Back Side With Double - Sided Tape	250	27,00 TL
	İRTU-PVC2	14 x 20 mm 0,50 PVC Etiket Arkası Tamamen Çift Taraflı Bantlı / 14 x 20 mm 0,50 PVC Label Back Side With Double - Sided Tape	250	27,00 TL
	İRTU-PVC3	14 x 20 mm 0,50 PVC Etiket Arkası Tamamen Çift Taraflı Bantlı / 14 x 20 mm 0,50 PVC Label Back Side With Double - Sided Tape	250	27,00 TL
	İRTU-PVC5	14 x 20 mm 50 Micron PVC Etiket Arkası Tamamen Çift Taraflı Bantlı / 14 x 20 mm 0,50 PVC Label Back Side With Double - Sided Tape	250	27,00 TL
	İRTU-PVC6	14 x 20 mm 50 Micron PVC Etiket Arkası Tamamen Çift Taraflı Bantlı / 14 x 20 mm 0,50 PVC Label Back Side With Double - Sided Tape	250	27,00 TL
	İRTU-PVC13	14 x 20 mm 50 Micron PVC Etiket Arkası Tamamen Çift Taraflı Bantlı / 14 x 20 mm 0,50 PVC Label Back Side With Double - Sided Tape	250	27,00 TL

Sac Levha Etiketleri /
Sheet Metal Labels

Görsel / Icon	Kod / Code	Ürün Tanımı / Product Name	Koli Adedi / Box Qty.	Birim Fiyat Unit Price (Adet/pcs)
	İRTU-SAC4	14 x 20 Sac Levha / Sheet Metal	250	32,00 TL
	İRTU-SAC7	12 x 15 Sac Levha / Sheet Metal	250	32,00 TL
	İRTU-SAC8	14 x 20 Sac Levha / Sheet Metal	250	32,00 TL
	İRTU-SAC9	14 x 20 Sac Levha / Sheet Metal	250	32,00 TL
	İRTU-SAC10	14 x 20 Sac Levha / Sheet Metal	250	32,00 TL
	İRTU-SAC12	14 x 20 Sac Levha / Sheet Metal	250	32,00 TL

Kablo Taşıma Askısı Cable Carriers



Kod / Code	Ürün Tanımı / Product Name	Kutu Adedi / Box Qty	Birim Fiyat Unit Price (adet/pcs)
İRTU-7001	80'lik Kablo Taşıma Askısı / Cable Carrier	50	110,50 TL

- Dahili ortam ve tünel içi kablo taşıma olarak kullanılır.
Used as an indoor and tunnel cable carrier.
- Birbirine geçme monteli çoğaltılarak kullanılabilir.
Can be used by duplicating interlocking mounted.
- Plastik ve yanmaz özelliğindedir.
Plastic and inflammable.

Boru / Kablo Sabitleyiciler Pipe and Cable Fixing Elements



Kod / Code	Ürün Tanımı / Product Name	Kutu Adedi / Box Qty	Birim Fiyat Unit Price (adet/pcs)
İRTU-9001	Boru ve kablo Sabitleyicisi / Pipe and Cable Fixing Elements (8-36)	750	28,50 TL
İRTU-9002	Boru ve kablo Sabitleyicisi / Pipe and Cable Fixing Elements (14-48)	250	97,80 TL
İRTU-9003	Boru ve kablo Sabitleyicisi / Pipe and Cable Fixing Elements (24-72)	250	145,00 TL

Boru / Kablo Bağlantı Rayları Pipe and Cable Connection Rail



Kod / Code	Ürün Tanımı / Product Name	Kutu Adedi / Box Qty	Birim Fiyat Unit Price (mt/mt)
İRTU-MR9001	Galvaniz Ray / Galvanized Rail (8-36) (2 mt)	100	
İRTU-MR9002	Galvaniz Ray / Galvanized Rail (14-48 / 24-72) (2 mt)	100	

Tırnaklı Kroşeler (Plastik) Plastic Click-fit Cable Clips

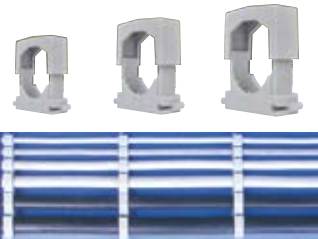

Kod / Code	Ürün Tanımı / Product Name	Kutu Adedi / Box Qty	Birim Fiyat Unit Price (adet/pcs)
İRTU-5155	No. 1 Tırnaklı Kroşe / Plastic Click-fit Cable Clips 2 x 1.5 / 2 x 2.5 / 2 x 4 / 2 x 6 3 x 1.5 / 4 x 1.5 / 3 x 2.5 / 4 x 2.5	100	21,75 TL
İRTU-5156	No. 2 Tırnaklı Kroşe / Plastic Click-fit Cable Clips 4 x 4 / 4 x 6	100	28,10 TL
İRTU-5157	No. 3 Tırnaklı Kroşe / Plastic Click-fit Cable Clips 4 x 10 NYM / 3 x 16 + 10 NYY	100	29,35 TL
İRTU-5158	No. 4 Tırnaklı Kroşe / Plastic Click-fit Cable Clips 3 x 25 + 16 / 3 x 35 + 16 / 3 x 50 + 25 NYY	25	30,30 TL

Makine Kapak Kulpları
Machine Holder

Kod / Code	Ürün Tanımı / Product Name	Ölçü / Size	Kutu Ad. / Box Qty	Birim Fiyat / Unit Price (tkm/set)
İRTU-KP200	Makine Kapak Kulbu L: 200 mm / Machine Handle L: 200 mm	200	10	
İRTU-KP300	Makine Kapak Kulbu L: 300 mm / Machine Handle L: 300 mm	300	10	
İRTU-KP400	Makine Kapak Kulbu L: 400 mm / Machine Handle L: 400 mm	400	10	
İRTU-KP500	Makine Kapak Kulbu L: 500 mm / Machine Handle L: 500 mm	500	10	
İRTU-KP100	Makine Kapak Kulbu Kenar Parçası / Machine Handle Part 1	500	10	
İRTU-KP050	Geçme Kapak Tutamağı - Elçek / Machine Handle Part 2	500	10	

Pano Perde Civatası
Panel Screen Screw

Kod / Code	Ürün Tanımı / Product Name	Kutu Ad. / Box Qty	Birim Fiyat / Unit Price (tkm/set)
İRTU-PV0610	M6x10 Pano Perde Civatası / CurtainWall M6x10 Bolt	500	
İRTU-PV0615	M6x15 Pano Perde Civatası / CurtainWall M6x15 Bolt	500	
İRTU-PV0620	M6x20 Pano Perde Civatası / CurtainWall M6x20 Bolt	500	
İRTU-PV0625	M6x25 Pano Perde Civatası / CurtainWall M6x25 Bolt	500	
İRTU-PV0630	M6x30 Pano Perde Civatası / CurtainWall M6x30 Bolt	500	
İRTU-PV0635	M6x35 Pano Perde Civatası / CurtainWall M6x35 Bolt	500	
İRTU-PV1620	M6x20 Tornavida Başlı Civata / M6x20 Bolt Head Screwdriver	500	
İRTU-PV1625	M6x25 Tornavida Başlı Civata / M6x25 Bolt Head Screwdriver	500	
İRTU-PV1630	M6x30 Tornavida Başlı Civata / M6x30 Bolt Head Screwdriver	500	
İRTU-PV1635	M6x35 Tornavida Başlı Civata / M6x35 Bolt Head Screwdriver	500	
STPC-1011	Plastik Armut Kulp / Plastic Handle	500	

Plastik Cam Tutucu
Panel Glass Holder

Kod / Code	Ürün Tanımı / Product Name	Kutu Adedi / Box Qty	Birim Fiyat / Unit Price (Adet/pcs)
İRTU-CAMTUT 1010	Alçak Tip Cam Tutucu / Low Type Glass Holder	200	15,00 TL
İRTU-CAMTUT1020	Yüksek Tip Cam Tutucu / High Type Glass Holder	200	20,00 TL

Köşe Aparatı (Pano Kapakları için)
Corner Apparatus (For Clipboard Covers)

Kod / Code	Cinsi / Type	Koli Adedi/Box Qty.	Birim Fiyat / Unit Price (Adet/pcs)
İRTU-4195	Sağ Sol Köşe Aparatı	100	

Sürgü Kilitler
Sliding Locks

Kod / Code	Cinsi / Type	Sac Kalınlığı	Koli Adedi/Box Qty.	Birim Fiyat / Unit Price (Adet/pcs)
İRTU-SK0010	Sürgü Kilit	0.8 - 1.5 mm	50	
İRTU-SK0020	Mini Sürgü Kilit	0.8 - 1.5 mm	100	

PG Polyamid Körtapa
PG Polyamide Blindstop



Kod / Code	Ölçü / Size	Renk / Color	Kutu Adedi / Box Qty.	Birim Fiyatı / Unit Price (Adet/pcs)
İRTU-KT1007	PG-7	■ ■	250	
İRTU-KT1009	PG-9	■ ■	250	
İRTU-KT1011	PG-11	■ ■	250	
İRTU-KT1013	PG-13,5	■ ■	250	
İRTU-KT1016	PG-16	■ ■	250	
İRTU-KT1021	PG-21	■ ■	250	
İRTU-KT1029	PG-29	■ ■	150	
İRTU-KT1036	PG-36	■ ■	100	

Kauçuk Körtapa
Rubber Blindstop



DÜZ TİP / FLAT TYPE

Kod / Code	Ölçü / Size	Kutu Adedi / Box Qty.	Birim Fiyatı / Unit Price (Adet/pcs)
İRTU-KT5013	PG-13,5	100	8,60 TL
İRTU-KT5016	PG-16	100	9,40 TL
İRTU-KT5021	PG-21	100	11,70 TL
İRTU-KT5029	PG-29	100	18,85 TL
İRTU-KT5036	PG-36	100	34,45 TL
İRTU-KT5042	PG-42	100	39,65 TL
İRTU-KT5016.01	PG-16	100	9,65 TL

Plastik Tapa (RİVET)
Plastic Plug (RIVETS)



Kod / Code	Ürün Tanımı / Product Name	Kutu Adedi / Box Qty	Birim Fiyatı / Unit Price (Adet/pcs)
İRTU-TAPA1001	Plastik Tapa (Rivet) / Plastic Plug (Rivets)	1000	3,50 TL
İRTU-PUL1001	Plastik Perde Vidası Pulu	1000	4,30 TL

Pano Proje Cebi
Panel Project Pocket

Kod / Code	Ürün Tanımı / Product Name	Boy / Size	Renk/ Colour	Koli Adedi / Box Qty.	Birim Fiyat Unit Price (Adet/pcs)
İRTU-PCB303	Pano Proje Cebi / Panel Project Pocket	Bantsız / Tapeless	RAL7032	50	129,60 TL
İRTU-PCB403	Pano Proje Cebi / Panel Project Pocket	Bantlı / Banded	RAL7032	50	137,70 TL
İRTU-PCB304	Pano Proje Cebi / Panel Project Pocket	Bantsız / Tapeless	RAL7035	50	129,60 TL
İRTU-PCB404	Pano Proje Cebi / Panel Project Pocket	Bantlı / Banded	RAL7035	50	137,70 TL
İRTU-PCB305	Pano Proje Cebi / Panel Project Pocket	Bantsız / Tapeless	RAL9001	50	129,60 TL
İRTU-PCB405	Pano Proje Cebi / Panel Project Pocket	Bantlı / Banded	RAL9001	50	137,70 TL
İRTU-PCB603	Pano Proje Cebi / Panel Project Pocket	Bantsız / Tapeless	RAL7032	60	97,20 TL
İRTU-PCB503	Pano Proje Cebi / Panel Project Pocket	Bantlı / Banded	RAL7032	60	105,30 TL
İRTU-PCB604	Pano Proje Cebi / Panel Project Pocket	Bantsız / Tapeless	RAL7035	60	97,20 TL
İRTU-PCB504	Pano Proje Cebi / Panel Project Pocket	Bantlı / Banded	RAL7035	60	105,30 TL
İRTU-PCB605	Pano Proje Cebi / Panel Project Pocket	Bantsız / Tapeless	RAL9001	60	97,20 TL
İRTU-PCB505	Pano Proje Cebi / Panel Project Pocket	Bantlı / Banded	RAL9001	60	105,30 TL

Havalandırma Panjurları
Air Conditioning Shutters

Kod / Code	Ölçüler / Dimensions	Kutu Adedi / Box Qty	Birim Fiyat Unit Price (adet/pcs)
İRTU-PHV2001	ELYAFLI / FIBER 120 x 120 mm	50	📦
İRTU-PHV2002	ELYAFLI / FIBER 225 x 225 mm	50	📦

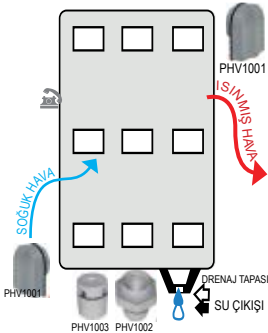
Pano Havalandırma Aparatı
Panel Air Conditioning Equipments

Kod / Code	Ölçüler / Dimensions	Boy / Size	Kutu Adedi / Box Qty	Birim Fiyat Unit Price (adet/pcs)
İRTU-PHV1001	Pano Havalandırma Aparatı / Panel Air Conditioning Equipment	M 40 x 1,5	50	70,00 TL
İRTU-PHV1002	Drenaj Tapası / Drainage Equipment	Ø 16	100	📦
İRTU-PHV1003	Drenaj Tapası / Drainage Equipment	M 25 x 1,5	50	📦

Pano Prizleri Panel Sockets



Kod / Code	Ürün Tanımı / Product Name	Koli Adedi / Box Qty.	Birim Fiyat / Unit Price (Adet/pcs)
İRTU-7160	Tek Giriş LED'siz Topraklı / Inlet Without LED	10	193,20 TL
İRTU-7161	Çift Giriş LED'siz Topraklı / Inlet & Outled Without LED	10	289,80 TL
İRTU-7162	Tek Giriş LED'li Topraklı / Inlet With LED	10	263,25 TL
İRTU-7163	Çift Giriş LED'li Topraklı / Inlet With LED	10	315,00 TL
İRTU-7164	Tek Giriş Ledsiz UPS'li / Inlet & UPS With LED	10	224,40 TL
İRTU-7165	Çift Giriş LED'siz UPS'li / Inlet & Outled & UPS Without LED	10	294,55 TL
İRTU-7166	Tek Giriş LED'li UPS'li / Inlet & UPS With LED	10	243,10 TL
İRTU-7167	Çift Giriş LED'li UPS'li / Inlet & Outled & UPS With LED	10	310,80 TL

Monofaze 1x16A Kapaklı Pano Prizleri Monophase 1x16A Covered Panel Sockets



Kod / Code	Ürün Tanımı / Product Name	Koli Adedi / Box Qty.	Birim Fiyat / Unit Price (Adet/pcs)
İRTU-ASG-AP2PN	1 x 16A Pano Priz (Mavi Kapak) / Panel Socket (Blue Cap)	50	
İRTU-MPP-1	1 x 16A Pano Priz (Mavi Kapak) / Panel Socket (Blue Cap)	10	

Pano İçi Isıtma ve Soğutma Termostatları Heating and Cooling Thermostats Inside Board



Kod / Code	Ürün Tanımı / Product Name	Kutu Adedi / Box Qty.	Birim Fiyat / Unit Price (Adet/pcs)
İRTU-KTO1010	Pano İçi Isıtma Termostatı (0-60 °C) / Panel Internal Heat Thermostat (0-60 °C)	1	280,00 TL
İRTU-KTO1020	Pano İçi Soğutma Termostatı (0-60 °C) / Panel Internal Cold Thermostat (0-60 °C)	1	280,00 TL
İRTU-KTO1030	Pano İçi Isıtma-Soğutma Termostatı (0-60 °C) / Panel Internal Heat-Cold Thermostat (0-60 °C)	1	

Pano Termostatı Panel Thermostat



Kod / Code	Ürün Tanımı / Product Name	Kutu Adedi / Box Qty.	Birim Fiyat / Unit Price (Adet/pcs)
İRTU-PNISIT10015	15 W Pano Isıtıcı (3 A) / Panel Heater	1	
İRTU-PNISIT10045	45 W Pano Isıtıcı (3,5 A) / Panel Heater	1	
İRTU-PNISIT10100	100 W Pano Isıtıcı (4,5 A) / Panel Heater	1	
İRTU-PNISIT10150	150 W Pano Isıtıcı (9 A) / Panel Heater	1	

BAĞLANTI EKİPMANLARI

YÜKSÜKLER



- Standart Yüksükler.
- Çatal Tip Yüksükler.
- Yuvarlak Tip Kablo Ucu.
- İğne Tip Kablo Ucu.
- Dişi Faston Kablo Uçları.

KABLO PAPUÇLARI



- Standart Kablo Papuçları.
- Kaynaklı Kablo Papuçları.
- Alüminyum Skp
- Alüminyum - Bakır Ek Muflar.
- KJB Tip Metalik Bağlantı Uçları.

KABLO TOPLAYICILAR



- Kablo Çorapları.
- Helezon Kablo Spiralleri.
- Isı İle Daralan Makaronlar.
- Silikon Makaronlar.
- Kablo Bağları.

BAĞLANTI AKSESUARLARI



- Pano Fırçaları.
- Pano Fitol ve Contaları.
- Kablo Kanalları.
- Pirinç ve Polyamid Rakorlar.
- Spiral Boru ve Rakorları.

MONTAJ RAYLARI



- Pano İçi Montaj Rayları.
- MG Tip Montaj Rayları.
- Profil Destek Rayları.
- Ray Taşıyıcı.
- Ray Yükseltme Aparatları.

İzoleli Tek Girişli Yüksükler
Insulated Single Cord End Terminals

Kod 1 / Code 1	Alman Norm / German Norm	Kod 2 / Code 2	Fransız Norm / French Norm	Kablo Kesiti / Cable Cross Section	Ölçüler / Dimension				Kutu Adedi/ Box Qty.	Birim Fiyat/ Unit Price (adet / pcs)
					F	L	C	W		
İRTU-IYT005006	■	İRTU-IYT005006F	□	0.50 mm ²	6,0	12,0	1,00	2,60	1000	0,418 TL
İRTU-IYT005008		İRTU-IYT005008F			8,0	14,0				
İRTU-IYT005010		İRTU-IYT005010F			10,0	16,0				
İRTU-IYT007506	□	İRTU-IYT007506F	■	0.75 mm ²	6,0	12,0	1,2	2,8	1000	0,418 TL
İRTU-IYT007508		İRTU-IYT007508F			8,0	14,0				
İRTU-IYT007510		İRTU-IYT007510F			10,0	16,0				
İRTU-IYT007512		İRTU-IYT007512F			12,0	18,0				
İRTU-IYT010006	■	İRTU-IYT010006F	■	1.00 mm ²	6,0	12,0	1,4	3,0	1000	0,418 TL
İRTU-IYT010008		İRTU-IYT010008F			8,0	14,0				
İRTU-IYT010010		İRTU-IYT010010F			10,0	16,0				
İRTU-IYT010012		İRTU-IYT010012F			12,0	18,0				
İRTU-IYT015008	■	İRTU-IYT015008F	■	1.50 mm ²	8,0	14,0	1,7	3,5	1000	0,467 TL
İRTU-IYT015010		İRTU-IYT015010F			10,0	16,0				
İRTU-IYT015012		İRTU-IYT015012F			12,0	18,0				
İRTU-IYT015018		İRTU-IYT015018F			18,0	24,0				
İRTU-IYT025008	■	İRTU-IYT025008F	■	2.50 mm ²	8,0	14,0	2,2	4,2	500	0,590 TL
İRTU-IYT025010		İRTU-IYT025008F			10,0	16,0				
İRTU-IYT025012		İRTU-IYT025008F			12,0	18,0				
İRTU-IYT025018		İRTU-IYT025008F			18,0	24,0				
İRTU-IYT040010	■	İRTU-IYT040010F	■	4.00 mm ²	10,0	17,0	2,8	2,8	500	0,984 TL
İRTU-IYT040012		İRTU-IYT040012F			12,0	20,0				
İRTU-IYT040018		İRTU-IYT040018F			18,0	26,0				
İRTU-IYT060012	■	İRTU-IYT060012F	■	6.00 mm ²	12,0	20,0	3,5	6,3	250	1,353 TL
İRTU-IYT060018		İRTU-IYT060018F			18,0	26,0				
İRTU-IYT100012	■	İRTU-IYT100012F	■	10.00 mm ²	12,0	22,0	4,5	7,6	100	1,685 TL
İRTU-IYT100018		İRTU-IYT100018F			18,0	28,0				
İRTU-IYT160012	■	İRTU-IYT160012F	■	16.00 mm ²	12,0	24,0	5,8	8,8	100	2,337 TL
İRTU-IYT160018		İRTU-IYT160018F			18,0	32,0				
İRTU-IYT250016	■	İRTU-IYT250016F	■	25.00 mm ²	16,0	30,0	7,3	11,0	50	3,936 TL
İRTU-IYT250018		İRTU-IYT250018F			18,0	32,0				
İRTU-IYT250022		İRTU-IYT250022F			22,0	36,0				
İRTU-IYT350016	■	İRTU-IYT350016F	■	35.00 mm ²	16,0	30,0	7,3	11,2	50	4,920 TL
İRTU-IYT350018		İRTU-IYT350018F			18,0	32,0				
İRTU-IYT350025		İRTU-IYT350025F			25,0	36,0				
İRTU-IYT500020	■	İRTU-IYT500020F	■	50.00 mm ²	20,0	36,0	10,3	15,0	25	9,225 TL
İRTU-IYT500025		İRTU-IYT500025F			25,0	40,0				
İRTU-IYT700021	■	İRTU-IYT700021F	■	70.00 mm ²	21,0	37,0	13,5	16,0	25	17,220 TL
İRTU-IYT950025	■	İRTU-IYT950025F	■	95.00 mm ²	25,0	44,0	14,7	18,0	25	

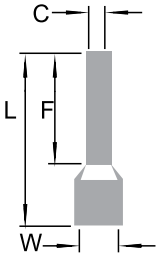

Bakır Malzemeden Kalay Kaplı, Polyamid İzoleli -40°C + 150°C Çalışma Sıcaklığı DIN 46228
Tin-Plated Copper Material, Polyamide Insulated -40 °C to + 150 °C Operating Temperature DIN 46228

İzoleli Çift Girişli Yüksükler DIN 46228
Insulated Twin Cord End Terminals DIN 46228



Kod 1 / Code 1	Alman Norm / German Norm	Kod 2 / Code 2	Fransız Norm / French Norm	Kablo Kesiti / Cable Cross Section	Ölçüler / Dimension				Kutu Adedi / Box Qty.	Birim Fiyat / Unit Price (adet / pcs)
					F	L	C	W		
İRTU-IYC2005008	Turuncu / Orange	İRTU-IYC2005008F	Beyaz / White	2x0.50 mm ²	8,0	15,0	1,5	2,5 / 4,7	1000	0,738 TL
İRTU-IYC2007508	Beyaz / White	İRTU-IYC2007508F	Mavi / Blue	2x0.75 mm ²	8,0	15,0	1,8	2,8 / 5,0	500	0,787 TL
İRTU-IYC2007510		İRTU-IYC2007510F			10,0	17,0				0,836 TL
İRTU-IYC2010008	Sarı / Yellow	İRTU-IYC2010008F	Kırmızı / Red	2x1.0 mm ²	8,0	15,0	2,05	3,4 / 5,4	500	0,836 TL
İRTU-IYC2010010		İRTU-IYC2010010F			10,0	17,0				1,009 TL
İRTU-IYC2015008	Kırmızı / Red	İRTU-IYC2015008F	Siyah / Black	2x1.5 mm ²	8,0	16,0	2,3	3,6 / 6,6	500	1,009 TL
İRTU-IYC2015010		İRTU-IYC2015010F			10	18				1,636 TL
İRTU-IYC2015012		İRTU-IYC2015012F			12,0	20,0				1,636 TL
İRTU-IYC2025010	Mavi / Blue	İRTU-IYC2025010F	Gri / Grey	2x2.5 mm ²	10,0	18,5	2,8	4,2 / 7,8	250	1,636 TL
İRTU-IYC2025013		İRTU-IYC2025013F			13,0	21,5				1,907 TL
İRTU-IYC2040012	Gri / Grey	İRTU-IYC2040012F	Turuncu / Orange	2x4.0 mm ²	12,0	23,0	3,7	4,9 / 8,8	200	1,907 TL
İRTU-IYC2060014	Siyah / Black	İRTU-IYC2060014F	Yeşil / Green	2x6.0 mm ²	14,0	26,0	4,8	6,9 / 10,0	100	2,399 TL
İRTU-IYC2100014	Bej / Beige	İRTU-IYC2100014F	Kahve / Brown	2x10.0 mm ²	14,0	26,5	6,4	7,6 / 12,8	50	3,629 TL
İRTU-IYC2160014	Yeşil / Green	İRTU-IYC2160014F	Bej / Beige	2x16.0 mm ²	14,0	31,5	0,3	9,6 / 18,6	50	4,551 TL

İzoleli Çatal Tip Kablo Ucu DIN 46237
Insulated Fork Type End Terminals DIN 46237



Kod / Code	Renk / Color	Kablo Kesiti Cable Cross Section	Metrik Ölçüsü Metric Size (d2)	Ölçüler / Dimensions						Kutu Ad. Box Qty	Birim Fiyat Unit / Price (adet/pcs)
				B	L	F	E	D	d1		
İRTU-İÇ0503258	Kırmızı / Red	0,5-1,5 mm ²	3,2	5,8	21,0	6,3	10,0	4,1	1,7	200	1,845 TL
İRTU-İÇ0503772			3,7	7,2	21,0	6,3					1,882 TL
İRTU-İÇ0504372			4,3	7,2	21,0	6,3					1,968 TL
İRTU-İÇ0505395			5,3	9,5	21,0	7,0					2,214 TL
İRTU-İÇ0506512			6,5	12,0	27,2	11,0					2,030 TL
İRTU-İÇ1503258	Mavi / Blue	1,5-2,5 mm ²	3,2	5,8	21,0	6,3	10,0	4,5	2,3	200	2,030 TL
İRTU-İÇ1503764			3,7	6,4	21,0	6,3					2,091 TL
İRTU-İÇ1504364			4,3	6,4	21,0	6,3					2,153 TL
İRTU-İÇ1505395			5,3	9,5	22,0	7,2					2,829 TL
İRTU-İÇ1506512			6,5	12,0	27,2	11,0					4,551 TL
İRTU-İÇ4003772	Sarı / Yellow	4,0-6,0 mm ²	3,7	7,2	25,2	7,5	12,5	6,5	3,4	100	4,613 TL
İRTU-İÇ4004385			4,3	8,5	25,2	7,5					7,257 TL
İRTU-İÇ4005395			5,3	9,5	25,2	7,5					
İRTU-İÇ4006595			6,5	9,5	25,2	7,5					
İRTU-İÇ8004382	Kırmızı / Red	8,0-10,0 mm ²	4,3	8,2	29,0	8,1	17,0	8,0	4,5	100	
İRTU-İÇ8005390			5,3	9,0	29,0	8,1					
İRTU-İÇ8006510			6,5	10,8	30,5	8,6					

* Bakır malzemeden kalay kaplı, PVC izoleli, 105°C çalışma sıcaklığı, 600 Volt enerjiye dayanma özelliği

* Copper material, tin-plated, PVC insulated, operating temperature 105°C, 600 Volt energy withstand capability.

İzoleli Yuvarlak Tip Kablo Ucu DIN 46228
Insulated Ring Type End Terminals DIN 46228



Kod / Code	Renk / Color	Kablo Kesiti Cable Cross Section	Metrik Ölçüsü (d2)	Ölçüler / Dimensions						Kutu Ad. Box Qty	Birim Fiyat Unit / Price (adet/pcs)
				B	L	F	E	D	d1		
İRTU-İY0503255	Kırmızı / Red	0,5-1,5 mm ²	3,2	5,5	16,7	4,0	10,0	4,1	1,7	200	1,353 TL
İRTU-İY0504380			4,3	8,0	21,0	7,0					2,005 TL
İRTU-İY0505380			5,3	8,0	21,0	7,0					2,030 TL
İRTU-İY0506511			6,5	11,6	26,8	11,1					3,198 TL
İRTU-İY0508411			8,4	11,6	26,8	11,1					3,198 TL
İRTU-İY1503264	Mavi / Blue	1,25-2,5 mm ²	3,2	6,4	17,5	4,3	10,0	4,5	2,3	200	2,460 TL
İRTU-İY1504366			4,3	6,6	19,6	6,3					2,460 TL
İRTU-İY1505385			5,3	8,5	22,0	7,8					2,522 TL
İRTU-İY1506512			6,5	12,0	27,0	11,0					3,567 TL
İRTU-İY1508412			8,4	12,0	27,0	11,0					3,567 TL
İRTU-İY1510513	10,5	13,6	30,7	13,9	100	3,690 TL					
İRTU-İY4004372	Sarı / Yellow	4,0-6,0 mm ²	4,3	7,2	22,0	5,9	12,5	6,5	3,4	100	5,228 TL
İRTU-İY4005395			5,3	9,5	25,5	8,3					5,228 TL
İRTU-İY4006512			6,5	12,0	29,0	10,5					5,904 TL
İRTU-İY4008415			8,4	15,0	33,7	13,7					7,626 TL
İRTU-İY4010515			10,5	15,0	33,7	13,7					7,749 TL
İRTU-İY4013019			13,0	19,2	38,1	16,0					7,872 TL
İRTU-İY8005515	Kırmızı / Red	8,0-10,0 mm ²	6,7	12,0	32,5	9,7				50	8,610 TL
İRTU-İY8008415			8,4	15,0	38,0	13,8					10,455 TL

* Bakır malzemeden kalay kaplı, PVC izoleli, 105 °C çalışma sıcaklığı, 600 Volt enerjiye dayanma özelliği

* Copper material, tin-plated, PVC insulated, operating temperature 105 °C, 600 Volt energy withstand capability.

İzoleli İğne Tip Kablo Ucu
Insulated Pin Type End Terminals



Kod / Code	Renk / Color	Kablo Kesiti Cable Cross Section	Ölçüler / Dimensions						Kutu Ad. Box Qty	Birim Fiyat Unit / Price (adet/pcs)
			B	L	F	E	D	d1		
İRTU-ii0051920	Kırmızı / Red	0,5-1,5 mm ²	1.9	20.5	10.5	10.5	4.1	1.7	200	
İRTU-ii0151920	Mavi / Blue	1,2-2,5 mm ²	1.9	20.5	10.5	10.5	4.5	2.3		
İRTU-ii0151922			1.9	22.5	12.5					
İRTU-ii0151928			1.9	28.5	18.5					
İRTU-ii0462826	Sarı / Yellow	4,0-6,0 mm ²	2.8	26.5	13.7	12.5	6.5	3.4	100	

* Bakır malzemeden kalay kaplı, PVC izoleli, 75 °C çalışma sıcaklığı, 600 Volt enerjiye dayanma özelliği

* Copper material, tin-plated, PVC insulated, operating temperature 75 °C, 600 Volt energy withstand capability.

İzoleli Dişi Faston Kablo Ucu DIN 46228
Insulated Faston Female End Terminals DIN 46228



Kod / Code	Renk / Color	Kablo Kesiti Cable Cross Section	Metrik Ölçüsü Metric Size (d2)	Ölçüler / Dimensions						Kutu Ad. Box Qty	Birim Fiyat Unit / Price (adet/pcs)
				B	L	F	E	D	d1		
İRTU-İF1050828	Kırmızı / Red	0,5 - 1,5 mm ²	0,8 x 2,8	3,2	18,5	6,4	10,0	4,3	1,7	200	
İRTU-İF0050848			0,8 x 4,8	5,0	19,0	6,5					
İRTU-İF0050864			0,8 x 6,4	6,6	21,0	7,9					
İRTU-İF0150828	Mavi / Blue	1,5 - 2,5 mm ²	0,8 x 2,8	3,2	18,5	6,4	10,0	5,0	2,3	200	
İRTU-İF0150848			0,8 x 4,8	5,0	19,0	6,5					
İRTU-İF0150864			0,8 x 6,4	6,6	21,0	7,9					
İRTU-İF0400864	Sarı / Yellow	4,0 - 6,0 mm ²	0,8 x 6,4	6,6	23,5	7,9	12,5	6,5	3,4	100	
İRTU-İF0401295			12 x 9,5	9,9	28,5	12,5					

* Bakır malzemeden kalay kaplı, PVC izoleli, 75 °C çalışma sıcaklığı, 300 Volt enerjiye dayanma özelliği

* Copper material, tin-plated, PVC insulated, operating temperature 75 °C, 300 Volt energy withstand capability.

Full İzoleli Dişi Faston Kablo Ucu DIN 46237
Full Insulated Faston Female End Terminals DIN 46237



Kod / Code	Renk / Color	Kablo Kesiti Cable Cross Section	Metrik Ölçüsü Metric Size (d2)	Ölçüler / Dimensions						Kutu Ad. Box Qty	Birim Fiyat Unit / Price (adet/pcs)
				B	L	F	E	D	d1		
İRTU-FIF1050828	Kırmızı / Red	0,5 - 1,5 mm ²	0,8 x 2,8	3,2	19,0	6,4	10,0	4,3	1,7	200	
İRTU-FIF1050848			0,8 x 4,8	5,0	20,0	6,5					
İRTU-FIF1050864			0,8 x 6,4	6,6	22,0	7,9					
İRTU-İF0150828	Mavi / Blue	1,5 - 2,5 mm ²	0,8 x 2,8	3,2	19,0	6,4	10,0	5,0	2,3	200	
İRTU-İF0150848			0,8 x 4,8	5,0	20,0	6,5					
İRTU-İF0150864			0,8 x 6,4	6,6	22,0	7,9					
İRTU-İF0400864	Sarı / Yellow	4,0 - 6,0 mm ²	0,8 x 6,4	6,6	25,0	7,9	13,0	6,5	3,4	100	

* Bakır malzemeden kalay kaplı, PVC izoleli, 105 °C çalışma sıcaklığı, 600 Volt enerjiye dayanma özelliği

* Copper material, tin-plated, PVC insulated, operating temperature 105 °C, 600 Volt energy withstand capability.

Bıçak Tip Kablo Ucu
Blade Type Cord End Terminals

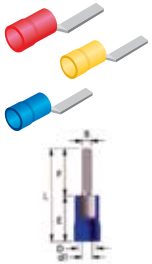

Kod / Code	Renk / Color	Kablo Kesiti Cable Cross Section	Ölçüler / Dimensions						Kutu Ad. Box Qty	Birim Fiyat Unit / Price (adet/pcs)
			B	L	F	E	D	d1		
İRTU-İB0524021	Kırmızı / Red	0,5 - 1,5 mm ²	2,4	21,5	10,5	11,0	4,1	1,7	100	
İRTU-İB0530022			3,0	22,0	11,0					
İRTU-İB0530025			3,0	25,0	14,0					
İRTU-İB1528020	Mavi / Blue	1,5 - 2,5 mm ²	2,8	20,0	9,0	11,0	4,5	2,3	100	
İRTU-İB1524029			2,4	29,0	18,0					
İRTU-İB4030031	Sarı / Yellow	4,0 - 6,0 mm ²	3,0	31,0	18,0	13,0	6,5	3,4	100	

* Bakır malzemeden kalay kaplı, PVC izoleli, 105 °C çalışma sıcaklığı, 600 Volt enerjiye dayanma özelliği

* Copper material, tin-plated, PVC insulated, operating temperature 105 °C, 600 Volt energy withstand capability.

Standart SKP Kablo Pabucu
Standart Cable Lug

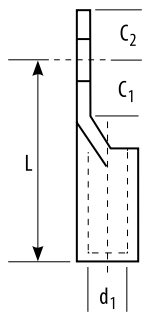
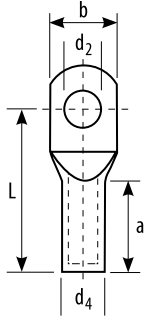

Kod / Code	Kablo Kesiti (mm ²) Cable Diameter (mm ²)	Cıvata Metric	Ölçüler / Dimension							Koli Adedi Box Qty	Birim Fiyat Unit Price (adet/pcs)	
			d1	d4	a	d2	b	c1	c2			L
İRTU-SKPS00604	6	M4	4,0	5,5	9,5	4,3	9,0	6,5	6,5	19,0	1000	12,730 TL
İRTU-SKPS00604		M5	4,0	5,5	9,5	5,3	9,0	6,5	6,5	19,0	1000	12,730 TL
İRTU-SKPS00604		M6	4,0	6,0	10,0	6,5	10,5	7,0	7,5	22,5	700	12,730 TL
İRTU-SKPS00604		M8	4,0	6,0	10,0	8,4	13,5	8,0	8,5	24,5	600	12,730 TL
İRTU-SKPS01005	10	M5	4,5	6,0	11,5	5,3	9,0	7,0	7,0	21,0	800	13,530 TL
İRTU-SKPS01006		M6	4,5	6,5	13,0	6,5	10,5	7,0	7,0	23,0	500	13,530 TL
İRTU-SKPS01008		M8	4,5	6,5	13,0	8,4	13,5	7,5	7,5	24,5	500	13,530 TL
İRTU-SKPS01010		M10	4,5	6,5	13,0	10,5	15,0	10,0	10,0	25,0	500	13,530 TL
İRTU-SKPS01606	16	M6	5,5	7,5	12,5	6,5	11,5	7,5	7,5	24,0	400	18,450 TL
İRTU-SKPS01608		M8	5,5	7,5	13,0	8,4	13,5	7,5	7,5	24,5	400	22,140 TL
İRTU-SKPS01610		M10	5,5	7,5	13,0	10,5	15,0	10,0	10,0	25,0	400	22,140 TL
İRTU-SKPS02506		25	M6	7,0	9,5	15,5	6,5	14,0	8,5	8,5	27,5	300
İRTU-SKPS02508	M8		7,0	9,5	15,5	8,5	14,0	8,5	8,5	27,5	300	33,210 TL
İRTU-SKPS02510	M10		7,0	9,5	15,5	10,5	16,0	10,0	10,0	28,5	300	34,440 TL
İRTU-SKPS02512	M12		7,0	9,5	15,5	13,0	18,0	11,0	11,0	32,0	250	34,440 TL
İRTU-SKPS03506	35	M6	8,5	11,0	16,5	6,5	16,0	9,5	9,5	32,0	200	45,510 TL
İRTU-SKPS03508		M8	8,5	11,0	16,5	8,5	16,0	9,5	9,5	32,0	200	45,510 TL
İRTU-SKPS03510		M10	8,5	11,0	16,5	10,5	16,0	10,0	10,0	32,0	200	49,200 TL
İRTU-SKPS03512		M12	8,5	11,0	16,5	13,0	18,0	11,0	11,0	34,0	150	49,200 TL
İRTU-SKPS05006	50	M6	10,0	13,0	18,0	6,5	19,0	11,0	11,0	37,5	125	66,420 TL
İRTU-SKPS05008		M8	10,0	13,0	18,0	8,5	19,0	11,0	11,0	37,5	125	66,420 TL
İRTU-SKPS05010		M10	10,0	13,0	18,0	10,5	19,0	11,0	11,0	37,5	125	71,340 TL
İRTU-SKPS05012		M12	10,0	13,0	18,0	13,0	19,0	11,0	11,0	37,5	125	71,340 TL
İRTU-SKPS07006	70	M6	11,5	14,5	20,0	6,5	21,0	11,0	11,0	40,0	80	94,710 TL
İRTU-SKPS07008		M8	11,5	14,5	20,0	8,5	21,0	11,0	11,0	40,0	80	94,710 TL
İRTU-SKPS07010		M10	11,5	14,5	20,0	10,5	21,0	11,0	11,0	40,0	80	94,710 TL
İRTU-SKPS07012		M12	11,5	14,5	21,5	13,0	21,0	11,0	11,0	40,0	80	94,710 TL
İRTU-SKPS07016		M16	11,5	14,5	20,0	16,5	23,0	16,0	16,0	45,0	70	105,780 TL
İRTU-SKPS09508	95	M8	13,5	16,5	22,0	8,5	24,0	12,5	12,5	45,0	60	116,850 TL
İRTU-SKPS09510		M10	13,5	16,5	22,0	10,5	24,0	12,5	12,5	45,0	60	116,850 TL
İRTU-SKPS09512		M12	13,5	16,5	22,0	13,0	24,0	12,5	12,5	45,0	60	116,850 TL
İRTU-SKPS09516		M16	13,5	16,5	22,0	16,5	26,0	16,0	16,0	47,5	50	116,850 TL
İRTU-SKPS12008	120	M8	14,5	18,0	24,0	8,5	26,5	14,0	14,0	49,0	50	166,050 TL
İRTU-SKPS12010		M10	14,5	18,0	24,0	10,5	26,5	14,0	14,0	49,0	50	166,050 TL
İRTU-SKPS12012		M12	14,5	18,0	24,0	13,0	26,5	14,0	14,0	49,0	50	166,050 TL
İRTU-SKPS12016		M16	14,5	18,0	24,0	16,5	26,5	14,0	14,0	49,0	40	166,050 TL
İRTU-SKPS15008	150	M8	16,5	21,0	27,0	8,5	30,5	15,5	15,5	55,0	30	261,990 TL
İRTU-SKPS15010		M10	16,5	21,0	27,0	10,5	30,5	15,5	15,5	55,0	30	261,990 TL
İRTU-SKPS15012		M12	16,5	21,0	27,0	13,0	30,5	15,5	15,5	55,0	30	261,990 TL
İRTU-SKPS15016		M16	16,5	21,0	27,0	16,5	30,5	15,5	15,5	55,0	30	261,990 TL

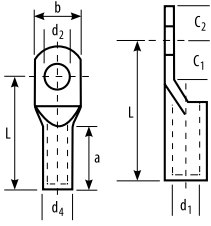
Standart SKP Kablo Pabucu
Standart Cable Lug

Kod / Code	Kablo Kesiti (mm ²) Cable Diameter (mm ²)	Cıvata Metric	Ölçüler / Dimension								Koli Adedi Box Qty	Birim Fiyat Unit Price (adet/pcs)
			d1	d4	a	d2	b	c1	c2	L		
İRTU-SKPS18510	185	M10	18,5	23,0	31,0	10,5	33,5	16,0	16,0	61,0	20	324,720 TL
İRTU-SKPS18512		M12	18,5	23,0	31,0	13,0	33,5	16,0	16,0	61,0	20	324,720 TL
İRTU-SKPS18516		M16	18,5	23,0	31,0	16,5	33,5	16,0	16,0	61,0	20	324,720 TL
İRTU-SKPS24010	240	M10	21,0	26,0	35,0	10,5	38,0	16,5	16,5	68,0	20	424,350 TL
İRTU-SKPS24012		M12	21,0	26,0	35,0	13,0	38,0	16,5	16,5	68,0	20	424,350 TL
İRTU-SKPS24016		M16	21,0	26,0	35,0	16,5	38,0	16,5	16,5	68,0	20	424,350 TL
İRTU-SKPS30012	300	M12	23,5	28,5	38,0	13,0	42,0	20,5	20,5	75,0	16	516,600 TL
İRTU-SKPS30016		M16	23,5	28,5	38,0	16,5	42,0	20,5	20,5	75,0	16	516,600 TL

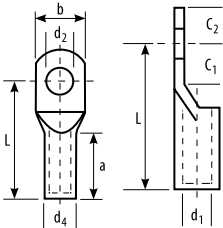
Standart SKP Kablo Pabucu (Eko Tip)
Standart Cable Lug (Eco Type)

Kod / Code	Kablo Kesiti (mm ²) Cable Diameter (mm ²)	Cıvata Metric	Ölçüler / Dimension								Koli Adedi Box Qty	Birim Fiyat Unit Price (adet/pcs)
			d1	d4	a	d2	b	c1	c2	L		
İRTU-SKPS01606E	16	M6	5,5	7	12,5	6,5	10,5	7,5	7,5	24	500	13,530 TL
İRTU-SKPS02508E	25	M8	7	9	15,5	8,5	14	8,5	8,5	27,5	300	24,600 TL
İRTU-SKPS03508E	35	M8	8,5	10,5	16,5	8,5	15,5	9,5	9,5	32	200	33,210 TL
İRTU-SKPS05010E	50	M10	10	12	18	10,5	18	11	11	37,5	125	46,740 TL
İRTU-SKPS07010E	70	M10	11,5	14	20	10,5	21	11	11	40	80	71,340 TL
İRTU-SKPS09512E	95	M12	13,5	16	22	13,5	24	12,5	12,5	45	60	86,100 TL
İRTU-SKPS12012E	120	M12	15,5	18	24	13,5	27	14	14	49	50	119,310 TL
İRTU-SKPS15012E	150	M12	16,5	20	26	13	29	14	14	51,5	35	196,800 TL
İRTU-SKPS18512E	185	M16	18,5	22	30,5	13	32	14,5	14,5	58,5	25	233,700 TL
İRTU-SKPS24012E	240	M16	21,5	25,5	33,5	13	37,5	16	16	66	20	338,250 TL

DIN 46234 İzolesiz (kaynaklı) Yuvarlak Kablo Pabucu

DIN 46234 Bare (welded) Round Cable Lug

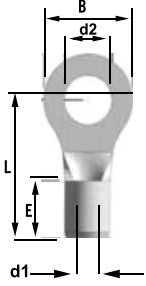

Kod / Code	Kablo Kesiti mm ² Cable Cross Section mm ²	Metrik Ölçüsü Metric Size	d1	L	B	E	d2	Koli Adedi Box Qty	Birim Fiyat Unit Price (Adet/pcs)
İRTU-SKPAL001030	0,5 - 1	M 3	1,6	10,8	6,0	4,8	3,2	1000	
İRTU-SKPAL001035		M 3,5	1,6	10,8	6,0	4,8	3,7	1000	
İRTU-SKPAL001040		M 4	1,6	11,8	8,0	4,8	4,3	1000	0,090 \$
İRTU-SKPAL001050		M 5	1,6	12,8	10,0	4,8	5,3	1000	0,099 \$
İRTU-SKPAL001060		M 6	1,6	14,8	11,0	4,8	6,5	1000	
İRTU-SKPAL001080		M 8	1,6	17,0	14,0	4,8	8,4	1000	
İRTU-SKPAL002030	1,5 - 2,5	M 3	2,3	10,8	6,0	4,8	3,2	1000	
İRTU-SKPAL002035		M 3,5	2,3	10,8	6,0	4,8	3,7	1000	0,080 \$
İRTU-SKPAL002040		M 4	2,3	11,8	8,0	4,8	4,3	1000	0,090 \$
İRTU-SKPAL002050		M 5	2,3	13,8	10,0	4,8	5,3	1000	0,116 \$
İRTU-SKPAL002060		M 6	2,3	15,8	11,0	4,8	6,5	1000	
İRTU-SKPAL002080		M 8	2,3	16,8	14,0	4,8	8,4	1000	0,176 \$
İRTU-SKPAL002100		M 10	2,3	17,0	15,0	4,8	10,5	1000	0,233 \$
İRTU-SKPAL002120		M 12	2,3	20	18	4,8	12	1000	
İRTU-SKPAL004040	4,0 - 6,0	M 4	3,6	14,0	8,0	6,0	4,3	100	0,197 \$
İRTU-SKPAL004050		M 5	3,6	15,0	10,0	6,0	5,3	100	0,197 \$
İRTU-SKPAL004060		M 6	3,6	16,0	11,0	6,0	6,5	100	0,207 \$
İRTU-SKPAL004080		M 8	3,6	19,0	14,0	6,0	8,4	100	0,255 \$
İRTU-SKPAL004100		M 10	3,6	21,0	18,0	6,0	10,5	100	0,335 \$
İRTU-SKPAL004120		M 12	3,6	21,0	18,0	6,0	13,0	100	0,336 \$
İRTU-SKPAL010050	10	M 5	4,5	16,0	10,0	8,0	5,3	100	0,315 \$
İRTU-SKPAL010060		M 6	4,5	17,0	11,0	8,0	6,5	100	0,323 \$
İRTU-SKPAL010080		M 8	4,5	20,0	14,0	8,0	8,4	100	0,371 \$
İRTU-SKPAL010100		M 10	4,5	21,0	18,0	8,0	10,5	100	0,450 \$
İRTU-SKPAL010120		M 12	4,5	23,0	22,0	8,0	13,0	100	0,464 \$
İRTU-SKPAL016050	16	M 5	5,8	20,0	11,0	10,0	5,3	100	
İRTU-SKPAL016060		M 6	5,8	20,0	11,0	10,0	6,5	100	0,497 \$
İRTU-SKPAL016080		M 8	5,8	22,0	14,0	10,0	8,4	100	0,533 \$
İRTU-SKPAL016100		M 10	5,8	24,0	18,0	10,0	10,5	100	0,603 \$
İRTU-SKPAL016120		M 12	5,8	26,0	22,0	10,0	13,0	100	0,671 \$
İRTU-SKPAL025050	25	M 5	7,5	25,0	12,0	11,0	5,3	100	
İRTU-SKPAL025060		M 6	7,5	25,0	12,0	11,0	6,5	100	0,810 \$
İRTU-SKPAL025080		M 8	7,5	25,0	16,0	11,0	8,4	100	0,926 \$
İRTU-SKPAL025100		M 10	7,5	26,0	18,0	11,0	10,5	100	0,972 \$
İRTU-SKPAL025120		M 12	7,5	31,0	22,0	11,0	13,0	100	1,158 \$
İRTU-SKPAL025160		M 16	7,5	35,0	28,0	11,0	17,0	100	



DIN 46234 İzolesiz (kaynaklı) Yuvarlak Kablo Pabucu
DIN 46234 Bare (welded Round Cable Lug)

Kod / Code	Kablo Kesiti mm ² Cable Dia. mm ²	Metrik Ölçüsü Metric Size	d1	L	B	E	d2	Koli Adedi Box Qty	Birim Fiyat Unit Price (Adet/pcs)
İRTU-SKPAL035060	35	M 6	9,0	26,0	15,0	12,0	6,5	100	1,275 \$
İRTU-SKPAL035080		M 8	9,0	26,0	16,0	12,0	8,4	100	1,275 \$
İRTU-SKPAL035100		M 10	9,0	27,0	18,0	12,0	10,5	100	1,275 \$
İRTU-SKPAL035120		M 12	9,0	31,0	22,0	12,0	13,0	100	1,391 \$
İRTU-SKPAL035160		M 16	9,0	35,0	28,0	12,0	17,0	100	1,391 \$
İRTU-SKPAL050060	50	M 6	11,0	34,0	18,0	16,0	6,5	100	2,202 \$
İRTU-SKPAL050080		M 8	11,0	34,0	18,0	16,0	8,4	100	2,202 \$
İRTU-SKPAL050100		M 10	11,0	34,0	18,0	16,0	10,5	100	2,202 \$
İRTU-SKPAL050120		M 12	11,0	36,0	22,0	16,0	13,0	100	2,202 \$
İRTU-SKPAL050160		M 16	11,0	40,0	22,0	16,0	17,0	100	2,316 \$
İRTU-SKPAL070060	70	M 6	15,0	38,0	22,0	18,0	6,5	100	3,135 \$
İRTU-SKPAL070080		M 8	15,0	38,0	22,0	18,0	8,4	100	3,135 \$
İRTU-SKPAL070100		M 10	15,0	38,0	22,0	18,0	10,5	100	3,135 \$
İRTU-SKPAL070120		M 12	15,0	38,0	22,0	18,0	13,0	100	3,245 \$
İRTU-SKPAL070160		M 16	15,0	42,0	28,0	18,0	17,0	100	3,245 \$
İRTU-SKPAL095080	95	M 8	15,0	42,0	24,0	20,0	8,4	100	3,383 \$
İRTU-SKPAL095100		M 10	15,0	42,0	24,0	20,0	10,5	100	3,383 \$
İRTU-SKPAL095120		M 12	15,0	42,0	24,0	20,0	13,0	100	3,476 \$
İRTU-SKPAL095160		M 16	15,0	44,0	28,0	20,0	17,0	100	3,476 \$
İRTU-SKPAL120080	120	M 8	16,5	44,0	24,0	22,0	8,4	50	6,956 \$
İRTU-SKPAL120100		M 10	16,5	44,0	24,0	22,0	10,5	50	6,956 \$
İRTU-SKPAL120120		M 12	16,5	44,0	24,0	22,0	13,0	50	6,956 \$
İRTU-SKPAL120160		M 16	16,5	48,0	28,0	22,0	17,0	50	6,956 \$
İRTU-SKPAL150100	150	M 10	19,0	50,0	30,0	24,0	10,5	50	18,533 \$
İRTU-SKPAL150120		M 12	19,0	50,0	30,0	24,0	13,0	50	18,533 \$
İRTU-SKPAL150160		M 16	19,0	50,0	30,0	24,0	17,0	50	18,533 \$
İRTU-SKPAL185120	185	M 12	21,0	50,0	36,0	28,0	13,0	50	18,533 \$
İRTU-SKPAL185160		M 16	21,0	50,0	36,0	28,0	17,0	50	18,533 \$
İRTU-SKPAL240120	240	M 12	23,5	56,0	38,0	32,0	13,0	50	18,533 \$
İRTU-SKPAL240160		M 16	23,5	56,0	38,0	32,0	17,0	50	18,533 \$

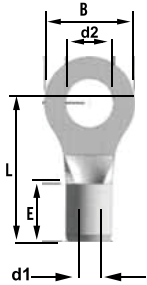

Bakır Alüminyumlu SKP (Bimetalik) / Bimetal (Al-Cu) Cable Lugs

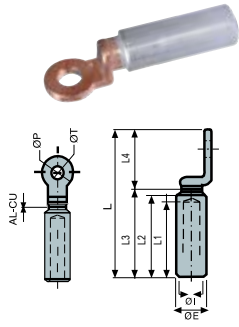

Kod / Code	Ref. No	K. Kesiti mm ²	ØE	ØI	L	L1	L2	L3	L4	ØT	ØP	Ağırlık	Ad. / \$	K. Ad.
İRTU-6108	CAL-C16	16	16	5,5	82	38	48	52	30	M8	10,5	7,2	10	30
İRTU-6109	CAL-C25	25	16	6,5	82	38	48	52	30	M8	10,5	7,2	10	30
İRTU-6110	CAL-C35	35	16	8,2	82	38	48	52	30	M8	10,5	7,2	10	30
İRTU-6111	CAL-C50	50	20	9,7	88	43	48	52	36	M10	10,5	7	10	30
İRTU-6112	CAL-C70	70	20	11	88	43	48	52	36	M10	10,5	7	10	30
İRTU-6113	CAL-C95	95	20	12,5	88	43	48	52	36	M10	10,5	6,3	10	30
İRTU-6114	CAL-C120	120	25	13,7	110	60	64	68	44	M10	10,5	13,5	10	30
İRTU-6115	CAL-C150	150	25	15,5	110	60	64	68	44	M10	10,5	12,2	10	30
İRTU-6116	CAL-C185	185	32	17,5	120	60	64	70	50	M12	10,5	20,1	10	30
İRTU-6117	CAL-C240	240	32	19,5	120	60	64	70	50	M12	10,5	22,6	10	15
İRTU-6118	CAL-C300	300	40	23	160	93	101	108	52	M12	13	33,4	10	9
İRTU-6119	CAL-C400	400	40	26,2	160	93	101	108	52	M12	13	30,2	10	9

Bakır Alüminyumlu SKP (Bimetalik Uzun Tip) / Bimetal (Al-Cu) Cable Lugs

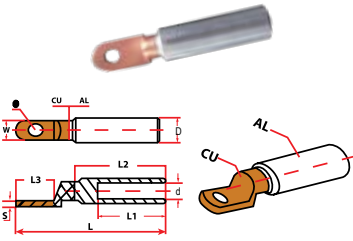

Kod / Code	Ref. No	K. Kesiti mm ²	D	d	L±1	L1	L2	L3	W	Q	S	Ad. / \$	K. Ad.
İRTU-6510	CAL-M16	16	16	5,5	82	38	50	23	14,0	8,5	3,2	10	30
İRTU-6511	CAL-M25	25	16	6,5	82	38	50	23	14,0	8,5	3,2	10	30
İRTU-6512	CAL-M35	35	16	8,2	82	38	50	23	14,0	8,5	3,2	10	30
İRTU-6513	CAL-M50	50	20	9,7	94	43	55	27	16,0	8,5	5,2	10	30
İRTU-6514	CAL-M70	70	20	11	94	43	55	27	16,0	8,5	5,2	10	30
İRTU-6515	CAL-M95	95	20	12,5	94	43	55	27	16,0	8,5	5,2	10	30
İRTU-6516	CAL-M120	120	25	14,5	120	60	72	32	23,0	10,5	6,5	10	30
İRTU-6517	CAL-M150	150	25	16,5	120	60	72	32	23,0	10,5	6,5	10	30
İRTU-6518	CAL-M185	185	32	17,5	133	60	73	38	23,0	12,5	8	10	30
İRTU-6519	CAL-M240	240	32	19,5	133	60	73	38	29,0	12,5	8	10	15
İRTU-6520	CAL-M300	300	34	23	133	61	73	35	29,0	12,5	8,5	10	10
İRTU-6521	CAL-M400	400	40	26,2	163	93	105	35	29,0	12,5	10,5	10	10
İRTU-6522	CAL-M500	500	40	29	163	93	105	35	29,0	12,5	10,5	10	10

Alüminyum-Bakır Ek Muf / Aluminium Copper Butt Connectors

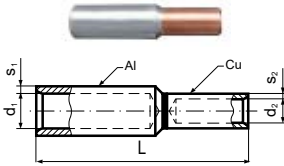

Kod / Code	AL KABLO KESİTİ	CU KABLO KESİTİ	d1	d2	L	v	K. Ad.
İRTU-6351	35 mm ²	16 mm ²	8,5	7,0	85,0	10	90
İRTU-6352	50 mm ²	25 mm ²	9,8	8,5	90,0	10	80
İRTU-6354	70 mm ²	35 mm ²	11,5	9,8	100,0	10	70
İRTU-6354	95 mm ²	50 mm ²	13,5	11,5	110,0	10	42
İRTU-6355	120 mm ²	70 mm ²	15,0	13,5	110,0	10	35
İRTU-6356	150 mm ²	95 mm ²	16,5	15,0	115,0	10	30
İRTU-6357	185 mm ²	120 mm ²	18,5	16,5	125,0	10	24
İRTU-6358	240 mm ²	150 mm ²	21,0	18,5	130,0	10	16

Alüminyum-Bakır Ek Muf / Aluminium Copper Butt Connectors (Pins)

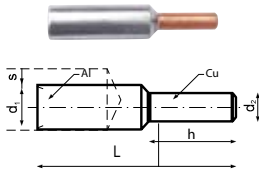

Kod / Code	K. Kesiti		d1	d2	L	h	Ad. / \$	K. Ad.
	Çok Tellî Kablo	Tek Damar Kablo						
İRTU-6333	10	16	12	5	58	15	10	100
İRTU-6334	16	25	12	6	58	15	10	100
İRTU-6335	25	35	6,8	6	58	20	10	50
İRTU-6336	35	50	8,0	7	71	22	10	50
İRTU-6337	50	70	9,8	8	74	25	10	80
İRTU-6338	70	95	11,2	10	87	30	10	70
İRTU-6339	95	120	13,2	12	91	33	10	48
İRTU-6340	120	150	14,7	12	97	38	10	35
İRTU-6341	150	185	16,3	12	108	38	10	30
İRTU-6342	185	240	18,3	14	116	44	10	24
İRTU-6343	240	300	21,0	16	128	44	10	16
İRTU-6344	300	-	23,3	18	131	46	10	9

KJB Tip Metalik Alüminyum-Bakır Bağlantı Elemanı / KJB Type Bimetal (Al-Cu)

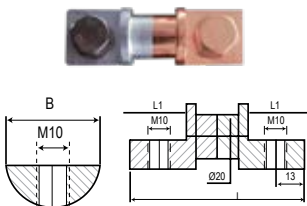

Kod / Code	Ref. No	L (mm)	L1 (mm)	B (mm)	Bolt Diameter	Ad. / \$	K. Ad.
İRTU-6530	KJB-26	80	26	26	M 10	10	24
İRTU-6531	KJB-29	80	26	29	M 10	10	24

Kablo Çorabı
Cable Socks

Kod / Code	Renk / Color	Ölçüler / Dimensions	Ambalaj Miktarı / Spool (mt)	Birim Fiyat / Unit Price (mt/euro)
İRTU-PKC03	Siyah / Black Gri / Grey	3 X 9 mm	300	0,267 \$
İRTU-PKC06	Siyah / Black Gri / Grey	6 x 11 mm	300	0,267 \$
İRTU-PKC08	Siyah / Black Gri / Grey	7 x 11 mm	100	0,284 \$
İRTU-PKC10	Siyah / Black Gri / Grey	10 x 17 mm	250	0,348 \$
İRTU-PKC12	Siyah / Black Gri / Grey	12 x 21 mm	150	0,405 \$
İRTU-PKC15	Siyah / Black Gri / Grey	15 x 24 mm	150	0,470 \$
İRTU-PKC20	Siyah / Black Gri / Grey	20 x 28 mm	150	0,535 \$
İRTU-PKC25	Siyah / Black Gri / Grey	25 x 36 mm	150	0,689 \$
İRTU-PKC30	Siyah / Black Gri / Grey	30 x 43 mm	100	0,851 \$
İRTU-PKC40	Siyah / Black Gri / Grey	40 x 60 mm	75	1,280 \$
İRTU-PKC50	SİYAH-GRİ / BLACK-GRAY	50 x 75 mm	75	1,701 \$

Halogen free, alev yaymaz / Halogen free, Non Flame Propagating

Helezon Kablo Toplama Spiralleri
Helezon Cable Collect Spirals

Kesilmiş 50cm



Rulo 10Mt

Kod / Code	Ürün Tanımı / Product Name	Kablo Kesit (mm ²) / Cable Diamete (mm ²)	Ölçüler / Dimensions			Ambalaj Miktarı / Spool (mt)	Birim Fiyat / Unit Price (mt/euro)
			F	E	L		
İRTU-HP01	NO: 1 (BOY / SIZE: 50 CM)	2.5 - 15	6	0.60	7.4	100	
İRTU-HP02	NO: 2 (BOY / SIZE: 50 CM)	6 - 30	8	0.75	12.0	100	
İRTU-HP03	NO: 3 (BOY / SIZE: 50 CM)	7.5 - 30	10	0.80	12.3	100	
İRTU-HP04	NO: 4 (BOY / SIZE: 50 CM)	9 - 32	12	0.85	15.0	100	
İRTU-HP05	NO: 5 (BOY / SIZE: 50 CM)	12 - 35	15	1.00	15.5	100	
İRTU-HR01	NO: 1 (BOY / SIZE: 10 MT)	2.5 - 15	6	0.60	7.4	10	9,45 TL
İRTU-HR02	NO: 2 (BOY / SIZE: 10 MT)	6 - 30	8	0.75	12.0	10	12,55 TL
İRTU-HR03	NO: 3 (BOY / SIZE: 10 MT)	7.5 - 30	10	0.80	12.3	10	14,85 TL
İRTU-HR04	NO: 4 (BOY / SIZE: 10 MT)	9 - 32	12	0.85	15.0	10	19,30 TL
İRTU-HR05	NO: 5 (BOY / SIZE: 10 MT)	12 - 35	15	1.00	15.5	10	31,05 TL

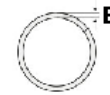
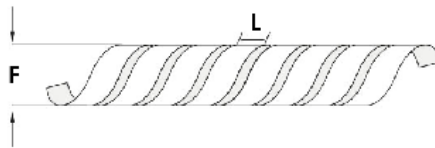

Polyefin, Halojen free, 2/1 Oranında Daralan RoHS ISO UL Sertifikalı
Polyefin, Halogen free, 2/1 Ratio Shrinkage RoHS ISO UL Certified



Kod / Code	Ölçü / Size		Daralmadan Önce Before Contraction (mm)		Daraldıktan Sonra After Contraction (mm)		Ambalaj Miktarı Spool (m)	Birim Fiyat Unit Price (adet/Pcs)
	Inc(Ø)	mm.	İç Çap Inside Diameter	Cıdar Kalınlığı Wall Thickness	İç Çap Inside Diameter	Cıdar Kalınlığı Wall Thickness		
İRTU-IDMS00015		1,5	2,0±0,2	0,18±0,05	0,85	0,32±0,10	200	0,131 \$
İRTU-IDMS00020		2	2,5±0,2	0,18±0,05	0,60	0,28±0,10	200	0,155 \$
İRTU-IDMS00024	3/32	2,4	3,0±0,3	0,18±0,05	1,2	0,35±0,10	200	0,155 \$
İRTU-IDMS00025		2,5	3,0±0,2	0,18±0,05	1,30	0,38±0,10	200	0,203 \$
İRTU-IDMS00030		3	3,5±0,2	0,18±0,05	1,50	0,40±0,10	200	0,216 \$
İRTU-IDMS00032	1/8	3,2	3,5±0,4	0,18±0,05	1,6	0,40±0,10	200	0,216 \$
İRTU-IDMS00035		3,5	4,0±0,2	0,22±0,05	1,80	0,42±0,10	200	0,230 \$
İRTU-IDMS00040		4	4,5±0,2	0,25±0,05	2,00	0,45±0,10	100	0,270 \$
İRTU-IDMS00045		4,5	5,0±0,2	0,25±0,05	2,30	0,50±0,10	100	0,311 \$
İRTU-IDMS00048	3/16	4,8	5,2±0,4	0,25±0,05	2,4	0,50±0,10	100	0,311 \$
İRTU-IDMS00050		5	5,5±0,2	0,25±0,05	2,50	0,55±0,10	100	0,338 \$
İRTU-IDMS00060		6	6,5±0,2	0,28±0,05	3,00	0,55±0,10	100	0,392 \$
İRTU-IDMS00064	1/4	6,4	7,0±0,4	0,28±0,05	3,2	0,55±0,10	100	0,392 \$
İRTU-IDMS00070		7	7,5±0,3	0,28±0,05	3,50	0,55±0,10	100	0,473 \$
İRTU-IDMS00080		8	8,5±0,3	0,28±0,05	4,00	0,60±0,10	100	0,473 \$
İRTU-IDMS00090		9	9,5±0,3	0,30±0,08	4,50	0,60±0,10	100	0,473 \$
İRTU-IDMS00095	3/8	9,5	10,0±0,5	0,30±0,08	4,8	0,60±0,10	100	0,473 \$
İRTU-IDMS00100		10	10,5±0,3	0,30±0,08	5,00	0,60±0,10	100	0,527 \$
İRTU-IDMS00110		11	11,5±0,3	0,30±0,08	5,50	0,60±0,10	100	0,527 \$
İRTU-IDMS00120		12	12,5±0,3	0,30±0,08	6,00	0,60±0,10	100	0,527 \$
İRTU-IDMS00127	1/2	12,7	13,0±0,5	0,30±0,08	6,4	0,60±0,10	100	0,608 \$
İRTU-IDMS00130		13	13,5±0,3	0,35±0,10	6,50	0,65±0,10	100	0,648 \$
İRTU-IDMS00140		14	14,5±0,3	0,35±0,10	7,00	0,65±0,10	100	0,756 \$
İRTU-IDMS00150		15	15,5±0,3	0,35±0,10	7,00	0,65±0,10	100	0,756 \$
İRTU-IDMS00160		16	16,5±0,4	0,40±0,12	8,00	0,70±0,10	100	1,013 \$
İRTU-IDMS00170		17	17,5±0,4	0,40±0,12	8,50	0,70±0,10	100	1,013 \$
İRTU-IDMS00180		18	19,0±0,5	0,40±0,15	9,00	0,80±0,15	100	1,323 \$
İRTU-IDMS00191	3/4	19,1	20,5±0,6	0,40±0,15	9,5	0,80±0,15	100	1,323 \$
İRTU-IDMS00200	4/5	20	21,0±0,6	0,40±0,15	10,00	0,80±0,15	100	1,688 \$
İRTU-IDMS00220		22	23,0±0,6	0,40±0,15	11,00	0,80±0,15	100	2,093 \$
İRTU-IDMS00254	1	25,4	25,6±0,7	0,50±0,15	12,70	0,90±0,15	50	2,228 \$
İRTU-IDMS00300		30	31,5±1,0	0,50±0,15	15,00	0,90±0,15	50	2,903 \$
İRTU-IDMS00302	1 1/4	32	33,0±0,7	0,50±0,15	15,9	0,95±0,15	50	2,903 \$
İRTU-IDMS00350		35	36,5±1,0	0,50±0,15	17,50	0,95±0,15	50	3,645 \$
İRTU-IDMS00380	1 1/2	38	40,0±0,7	0,50±0,15	19,1	1,00±0,15	50	4,050 \$
İRTU-IDMS00400		40	41,5±1,0	0,55±0,15	20,00	1,00±0,15	50	4,050 \$
İRTU-IDMS00510	2	51	52,5±0,7	0,55±0,15	25,4	0,95±0,15	25	5,130 \$
İRTU-IDMS00600		60	60,00	0,60±0,15	30,00	1,30±0,20	25	6,885 \$
İRTU-IDMS00700		70	70,00	0,65±0,15	35,00	1,30±0,20	25	9,180 \$
İRTU-IDMS00760	3	76	80,0±1,0	0,65±0,15	38,1	1,30±0,20	25	9,180 \$
İRTU-IDMS00800		80	80,00	0,65±0,15	40,00	1,46±0,20	25	10,125 \$
İRTU-IDMS00900		90	90,00	0,65±0,15	45,00	1,46±0,20	25	11,475 \$
İRTU-IDMS00960		96	100	0,65±0,15	50	1,46±0,20	25	11,475 \$
İRTU-IDMS01020	4	102	105±1,0	0,65±0,20	50,80	1,46±0,20	25	12,825 \$
İRTU-IDMS01200	5	120	120,00	0,65±0,20	63,50	1,56±0,20	20	17,550 \$
İRTU-IDMS01500		150	150,00	0,65±0,20	75,00	1,56±0,20	25	25,650 \$
İRTU-IDMS01800		180	180,00	0,65±0,20	90,00	1,56±0,20	25	36,450 \$

2/1 Isı ile Daralan Makaron (şeffaf, beyaz, kırmızı, gri, mavi, sarı-yeşil)
2/1 Rate Heat Shrink (transparent, white, red, grey, blue, yellow-green)



Kod / Code	Ölçü / Size		Ambalaj Miktarı Spool (mt)	Birim Fiyat Unit Price (mt / usd)	Kahverengi Brown (mt / usd)	Sarı-Yeşil Yellow-Green (mt / usd)
	Inch	mm				
İRTU-IDM00016	1/16	1,6	200	0.149 \$	0.162 \$	
İRTU-IDM00020		2	200			
İRTU-IDM00024	3/32	2,4	200			
İRTU-IDM00025		2,5	200	0.230 \$	0.243 \$	0.567 \$
İRTU-IDM00032	1/8	3,2	200	0.270 \$	0.297 \$	0.581 \$
İRTU-IDM00035		3,5	200	0.284 \$		
İRTU-IDM00048	3/16	4,8	100	0.365 \$	0.392 \$	0.594 \$
İRTU-IDM00050		5	100			
İRTU-IDM00064	1/4	6,4	100	0.446 \$	0.513 \$	0.675 \$
İRTU-IDM00070		7	100	0.446 \$	0.513 \$	
İRTU-IDM00095	3/8	9,5	100	0.527 \$	0.594 \$	0.918 \$
İRTU-IDM00100		10	100			
İRTU-IDM00120		12	100			
İRTU-IDM00127	1/2	12,7	100	0.743 \$	0.810 \$	1.350 \$
İRTU-IDM00160		16	100	1.148 \$	1.418 \$	1.958 \$
İRTU-IDM00191	3/4	19,1	100	2.025 \$	2.093 \$	2.565 \$
İRTU-IDM00200	4/5	20	100	2.025 \$	2.093 \$	2.565 \$
İRTU-IDM00254	1	25,4	50	2.565 \$	2.835 \$	3.713 \$
İRTU-IDM00320	1 1/4	32	50	3.240 \$	3.780 \$	4.995 \$
İRTU-IDM00350		35	50			
İRTU-IDM00380	1 1/2	38	50	4.860 \$	5.535 \$	6.750 \$
İRTU-IDM00510	2	51	50	5.670 \$	6.615 \$	\$
İRTU-IDM00600		60	25	7.830 \$	10.125 \$	14.500 \$
İRTU-IDM00700		70	25			
İRTU-IDM00760	3	76	25	10.800 \$	12.150 \$	21.750 \$
İRTU-IDM00960		96	25			
İRTU-IDM01020	4	102	25	14.850 \$	18.225 \$	33.350 \$
İRTU-IDM01200	5	120	25			
İRTU-IDM01500		150	25			
İRTU-IDM01800		180	25			

Silikon Makaronlar (2.5 kV)
Silicon Tubes (2.5 kV)

Kod / Code	Çap Dia. (mm)	Renkler / Colour	Rulo / Roll (mt)	Birim Fiyat Unit Price (mt / usd)
FG-SRG-0.70	0,7	Kırmızı - Siyah / Red - Black	100	
FG-SRG-1.00	1	Kırmızı - Siyah / Red - Black	100	
FG-SRG-1.50	1,5	Kırmızı - Siyah / Red - Black	100	
FG-SRG-2.00	2	Kırmızı - Siyah / Red - Black	100	0,311 \$
FG-SRG-2.50	2,5	Kırmızı - Siyah / Red - Black	100	
FG-SRG-3.00	3	Kırmızı - Siyah / Red - Black	100	0,486 \$
FG-SRG-3.50	3,5	Kırmızı - Siyah / Red - Black	100	
FG-SRG-4.00	4	Kırmızı - Siyah / Red - Black	100	0,648 \$
FG-SRG-5.00	5	Kırmızı - Siyah / Red - Black	100	0,783 \$
FG-SRG-6.00	6	Kırmızı - Siyah / Red - Black	100	0,959 \$
FG-SRG-7.00	7	Kırmızı - Siyah / Red - Black	100	1,107 \$
FG-SRG-8.00	8	Kırmızı - Siyah / Red - Black	100	1,283 \$
FG-SRG-10.00	10	Kırmızı - Siyah / Red - Black	100	1,755 \$
FG-SRG-12.00	12	Kırmızı - Siyah / Red - Black	50	2,160 \$
FG-SRG-14.00	14	Kırmızı - Siyah / Red - Black	50	2,592 \$
FG-SRG-16.00	16	Kırmızı - Siyah / Red - Black	50	3,483 \$
FG-SRG-18.00	18	Kırmızı - Siyah / Red - Black	50	4,536 \$
FG-SRG-20.00	20	Kırmızı - Siyah / Red - Black	25	5,805 \$
FG-SRG-25.00	25	Kırmızı - Siyah / Red - Black	25	11,070 \$



Standart Kablo Bağları / Standart Cable Ties

Kod / Code	Renk / Color	Kod 2 / Code 2	Renk / Color	L	W	Max. Bağlama Çapı / Max. Connecting Size	Taşıyıcı Ağırlık / Carrying Weight (kg)	Poşet Adedi/ Bag Qty	Koli Adedi/ Box Qty.	Birim Fiyat Unit Price (Adet/pcs)
İRTU-KBS10025	■	İRTU-KBB10025	□	100	2,5	22	8,1	100/1000	70.000	0,309 TL
İRTU-KBS15025	■	İRTU-KBB15025	□	150		33		100/1000	55.000	0,476 TL
İRTU-KBS20025	■	İRTU-KBB20025	□	200		53		100/100	45.000	0,655 TL
İRTU-KBS15036	■	İRTU-KBB15036	□	150	3,6	35	18,2	100/100	33.000	0,797 TL
İRTU-KBS20036	■	İRTU-KBB20036	□	200		53		100/100	25.000	1,035 TL
İRTU-KBS25036	■	İRTU-KBB25036	□	250		65		100/100	20.000	1,250 TL
İRTU-KBS30036	■	İRTU-KBB30036	□	300	4,8	76	22,2	100/100	20.000	1,583 TL
İRTU-KBS37036	■	İRTU-KBB37036	□	370		102		100/100	15.000	1,987 TL
İRTU-KBS20048	■	İRTU-KBB20048	□	200		50		100	16.000	1,476 TL
İRTU-KBS25048	■	İRTU-KBB25048	□	250	7,6	60	54,5	100	13.000	1,928 TL
İRTU-KBS30048	■	İRTU-KBB30048	□	300		76		100	13.000	2,202 TL
İRTU-KBS37048	■	İRTU-KBB37048	□	370		102		100	10.000	2,559 TL
İRTU-KBS40048	■	İRTU-KBB40048	□	400	9	102	79,4	100	10.000	2,916 TL
İRTU-KBS43048	■	İRTU-KBB43048	□	430		110		100	9.000	3,415 TL
İRTU-KBS25076	■	İRTU-KBB25076	□	250		60		100	6.500	4,522 TL
İRTU-KBS30076	■	İRTU-KBB30076	□	300	7,6	76	54,5	100	6.500	4,522 TL
İRTU-KBS37076	■	İRTU-KBB37076	□	370		102		100	5.000	4,879 TL
İRTU-KBS43076	■	İRTU-KBB43076	□	450		127		100	3.500	5,688 TL
İRTU-KBS53076	■	İRTU-KBB53076	□	530	9	140	79,4	100	3.000	7,438 TL
İRTU-KBS71076	■	İRTU-KBB71076	□	710		190		100	2.000	12,138 TL
İRTU-KBS76090	■	İRTU-KBB76090	□	760		236		100	2.000	15,470 TL
İRTU-KBS94090	■	İRTU-KBB94090	□	940	280	100	1.000	17,493 TL		

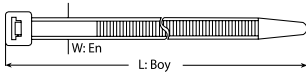

Metal Kablo Bağları / Stainless Steel Cable Ties

Kod / Code	L	W	Max. Bağlama Çapı / Max. Connecting Size	Taşıyıcı Ağırlık / Carrying Weight (kg)	Poşet Adedi/ Bag Qty	Birim Fiyat Unit Price 304 (Adet/pcs)
İRTU-MTL30415246	150	4,6	37	55	100	4,522 TL
İRTU-MTL30420146	200		50		100	5,117 TL
İRTU-MTL30426646	260		69		100	5,831 TL
İRTU-MTL30430046	300		76		100	6,188 TL
İRTU-MTL30436246	370		102		100	6,783 TL
İRTU-MTL30452146	520		152		100	8,568 TL
İRTU-MTL30467946	680	7,9	203	120	100	10,472 TL
İRTU-MTL30483846	840		254		100	12,495 TL
İRTU-MTL30420179	200		50		100	7,973 TL
İRTU-MTL30430079	300		76		100	9,282 TL
İRTU-MTL30436279	370		102		100	10,710 TL
İRTU-MTL30452179	520		152		100	13,685 TL
İRTU-MTL30467979	680	7,9	203	120	100	15,708 TL
İRTU-MTL30483879	840		254		100	19,635 TL



Etiketli Kablo Bağları / Cable Tie Labels

Kod / Code	L	W	Max. Bağlama Çapı / Max. Connecting Size	Taşıyıcı Ağırlık / Carrying Weight (kg)	Poşet Adedi/ Bag Qty	Birim Fiyat Unit Price 316 (Adet/pcs)
İRTU-EKB10025	100	2,5	20	8,1	100	1,107 TL
İRTU-EKB19025	190	4,8	48	22,2	100	2,380 TL



Yapışkan Kroşeler / Sticky Crochets

Kod / Code	A	B	C	D	H	Poşet Adedi/ Bag Qty	Birim Fiyat Unit Price (Adet/pcs)
İRTU-YKR1919	19	3,6	19	Ø3,2	4	100	1,625 TL
İRTU-YKR2727	28	4,8	28		4,5	100	2,860 TL



Alüminyum Pano Fırçası Aluminium



Kod / Code	Ürün Tanımı / Product Name	Kıl Boyu / Bristle Length	Uzunluk / Length (mt)	Kutu Ad. / Box Qty	Birim Fiyat Unit Price (Metre)
İRTU-FRA20030	ALÜMİNYUM PANO TOZ FIRÇASI / POWDER BRUSH ALUMINIUM PANELS	30	2	30	170,45 TL
İRTU-FRA20040	ALÜMİNYUM PANO TOZ FIRÇASI / POWDER BRUSH ALUMINIUM PANELS	40	2	30	190,75 TL
İRTU-FRA20050	ALÜMİNYUM PANO TOZ FIRÇASI / POWDER BRUSH ALUMINIUM PANELS	50	2	30	197,05 TL
İRTU-FRA20060	ALÜMİNYUM PANO TOZ FIRÇASI / POWDER BRUSH ALUMINIUM PANELS	60	2	30	237,65 TL
İRTU-FRA20070	ALÜMİNYUM PANO TOZ FIRÇASI / POWDER BRUSH ALUMINIUM PANELS	70	2	30	269,85 TL
İRTU-FRA20080	ALÜMİNYUM PANO TOZ FIRÇASI / POWDER BRUSH ALUMINIUM PANELS	80	2	30	291,20 TL
İRTU-FRA20100	ALÜMİNYUM PANO TOZ FIRÇASI / POWDER BRUSH ALUMINIUM PANELS	100	2	30	318,15 TL
İRTU-FRA20150	ALÜMİNYUM PANO TOZ FIRÇASI / POWDER BRUSH ALUMINIUM PANELS	150	2	30	675,85 TL

Plastik Pano Fırçası Plastic Panel Brush



RULO (FRP 22050)

Kod / Code	Ürün Tanımı / Product Name	Kıl Boyu / Bristle Length	Uzunluk / Length (mt)	Kutu Ad. / Box Qty	Birim Fiyat Unit Price (Metre)
İRTU-FRP20030	PLASTİK GEÇME PANO FIRÇASI / PLASTIC PROMOTION BOARD BRUSH	30	2	30	210,70 TL
İRTU-FRP20040	PLASTİK GEÇME PANO FIRÇASI / PLASTIC PROMOTION BOARD BRUSH	40	2	30	213,85 TL
İRTU-FRP20050	PLASTİK GEÇME PANO FIRÇASI / PLASTIC PROMOTION BOARD BRUSH	50	2	30	242,20 TL
İRTU-FRP20060	PLASTİK GEÇME PANO FIRÇASI / PLASTIC PROMOTION BOARD BRUSH	60	2	30	269,85 TL
İRTU-FRP20070	PLASTİK GEÇME PANO FIRÇASI / PLASTIC PROMOTION BOARD BRUSH	70	2	30	292,95 TL
İRTU-FRP20080	PLASTİK GEÇME PANO FIRÇASI / PLASTIC PROMOTION BOARD BRUSH	80	2	30	356,65 TL
İRTU-FRP20100	PLASTİK GEÇME PANO FIRÇASI / PLASTIC PROMOTION BOARD BRUSH	100	2	30	391,30 TL
İRTU-FRP22050	PLASTİK RULO PANO FIRÇASI (25 Mt) / PLASTIC ROLL BOARD BRUSH (25 Mt)	50	25	1	512,00 TL

Pano Kenar Fitolü U Panel Tape



Kod / Code	Ürün Tanımı / Product Name	Kutu Adedi Box Qty	Birim Fiyat Unit Price (tkm/set)
İRTU-FTL1004/S	U Siyah Sac Kenar Fitolü (0,80 mm-1,5 mm) U Black Panel Tape (0,80 mm-1,5 mm)	300	18,20 TL
İRTU-FTL1004/G	U Gri Sac Kenar Fitolü (0,80 mm-1,5 mm) U Gray Panel Tape (0,80 mm-1,5 mm)	300	18,20 TL
İRTU-FTL1006/S	U Siyah Sac Kenar Fitolü (2 mm-2,5 mm) U Black Panel Tape (2 mm-2,5 mm)	300	22,75 TL
İRTU-FTL1006/G	U Gri Sac Kenar Fitolü - (2 mm-2,5 mm) U Gray Panel Tape (2 mm-2,5 mm)	300	22,75 TL

Poliüretan Yapışkanlı Conta Polyurethane Sticky Gasket



Kod / Code	Ürün Tanımı / Product Name	Kutu Miktarı Box Qty (mt)	Birim Fiyat Unit Price (tkm/set)
İRTU-CNT0510	5 x 10 Poliüretan Yapışkanlı Conta / Polyurethane Sticky Gasket	300	28,00 TL
İRTU-CNT0515	5 x 15 Poliüretan Yapışkanlı Conta / Polyurethane Sticky Gasket	300	35,00 TL
İRTU-CNT0520	5 x 20 Poliüretan Yapışkanlı Conta / Polyurethane Sticky Gasket	300	52,50 TL

Pano İçi Montaj Rayı

Panel Mounting Rail



Kod / Code	Ölçü / Size (mm)	Ürün Tanımı / Product name	Tip / Type	Uzunluk Length (mt/mt)	Paket Miktarı Box Qty (mt)	Birim Fiyat Unit Price (mt)
İRTU-MR3010	35x7,5x1	Krom 3 (Cr+3)Coated Crom +3	Delikli / Perforated	2	80	
İRTU-MR3011	35x7,5x1	Krom 3 (Cr+3)Coated Crom +3	Deliksiz / Imperforated	2	80	
İRTU-MR4010	35x7,5x1	Galvaniz	Delikli / Perforated	2	80	87,50 TL
İRTU-MR4011	35x7,5x1	Galvaniz	Deliksiz / Imperforated	2	80	87,50 TL
İRTU-MR4010E	35x7,5x1	Galvaniz (Eko)	Delikli / Perforated	2	80	56,00 TL
İRTU-MR4011E	35x7,5x1	Galvaniz (Eko)	Deliksiz / Imperforated	2	80	56,00 TL
İRTU-MR3012	35x15x1,5	Krom 3 (Cr+3)	Delikli / Perforated	2	40	
İRTU-MR3013	35x15x1,5	Krom 3 (Cr+3)	Deliksiz / Imperforated	2	40	
İRTU-MR4015	35x15x1,5	Galvaniz	Delikli / Perforated	2	40	154,00 TL
İRTU-MR4013	35x15x1,5	Galvaniz	Deliksiz / Imperforated	2	40	154,00 TL

Pano İçi MG Tipi Montaj Rayı

MG Type Mounting Rail



Kod / Code	Tip /Type	Ürün Tanımı / Product Name	Uzunluk Length (mt)	Paket Miktarı Box Qty (mt)	Birim Fiyat Unit Price (Adet/pcs)
İRTU-4142	Deliksiz / Imperforated	Alüminyum / Aluminium	1	25	
İRTU-4143	Deliksiz / Imperforated	Alüminyum / Aluminium	2	25	
İRTU-4147	Delikli / Perforated	Alüminyum / Aluminium	1	25	
İRTU-4148	Delikli / Perforated	Alüminyum / Aluminium	2	25	

Profil Destek Rayı (Cr 3)

Profile Support Rail (Cr 3)



Kod / Code	Cinsi / Type	Koli Adedi / Box Qty.	Birim Fiyat/ Unit Price (Adet/pcs)
İRTU-4191	1 Metre U Profil (Cr3)	35	
İRTU-4192	2 Metre U Profil (Cr3)	35	
İRTU-4193	3 Metre U Profil (Cr3)	35	

Ray Taşıyıcı

Rail Carrier



Kod / Code	Ürün Tanımı / Product Name	Tip / Type	Paket Miktarı (mt)	Birim Fiyat Unit Price (Adet/pcs)
İRTU-MR1010	Cr+3 Kaplama / Coated Crom +3	Ray Taşıyıcı / Rail Carrier	100	
İRTU-MR1020	Alüminyum /Aluminium	Ray Taşıyıcı / Rail Carrier	100	

Ray Yükseltme Aparatı

Rail Lift Tool



Alüminyum Kod / Aluminium Code	Ölçü / Size (mm)	Paket Miktarı Box Qty (mt)	Birim Fiyat / Unit Price (Adet/pcs)	Metal Kod / Metal Code	Birim Fiyat/ Unit Price (Adet/pcs)
BA16050	Ø16x50 mm	100		BC16050	
BA16080	Ø16x80 mm	100		BC16080	
BA16100	Ø16x100 mm	100		BC16100	

Pano İçi Delikli Kablo Kanalı

Panel Internal Slotted Cable Trunking



Ölçü / Size	Ambalaj Miktarı / Packing Qty. (mt)	Kod / Code	B. Fiyat / Unit Price (₺/mt)	Kod / Code	Halojen Free B. Fiyat / Unit Price (₺/mt)
25x30 mm	84	İRTU-KN02530		İRTU-KN22530	
25x40 mm	84	İRTU-KN02540		İRTU-KN22540	
25x60 mm	48	İRTU-KN02560		İRTU-KN22560	
40x40 mm	60	İRTU-KN04040		İRTU-KN24040	
40x60 mm	36	İRTU-KN04060		İRTU-KN24060	
40x80 mm	40	İRTU-KN04080		İRTU-KN24080	
60x40 mm	36	İRTU-KN06040		İRTU-KN26040	
60x60 mm	24	İRTU-KN06060		İRTU-KN26060	
60x80 mm	24	İRTU-KN06080		İRTU-KN26080	
80x60 mm	24	İRTU-KN08060		İRTU-KN28060	
80x80 mm	24	İRTU-KN08080		İRTU-KN28080	
100x60 mm	24	İRTU-KN10060		İRTU-KN20060	

Pano İçi Delikli Kablo Kanalı (Gri Yapışkanlı)

Panel Internal Slotted Cable Trunking (Grey Self Adhesive)



Ölçü / Size	Ambalaj Miktarı / Packing Qty. (mt)	Kod / Code	B. Fiyat / Unit Price (₺/mt)	Kod / Code	Halojen Free B. Fiyat / Unit Price (₺/mt)
25x30 mm	84	İRTU-KN32530		İRTU-KN42530	
25x40 mm	84	İRTU-KN32540		İRTU-KN42540	
25x60 mm	48	İRTU-KN32560		İRTU-KN42560	
40x40 mm	60	İRTU-KN34040		İRTU-KN44040	
40x60 mm	36	İRTU-KN34060		İRTU-KN44060	
40x80 mm	40	İRTU-KN34080		İRTU-KN44080	
60x40 mm	36	İRTU-KN36040		İRTU-KN46040	
60x60 mm	24	İRTU-KN36060		İRTU-KN46060	
60x80 mm	24	İRTU-KN36080		İRTU-KN46080	
80x60 mm	24	İRTU-KN38060		İRTU-KN48060	
80x80 mm	24	İRTU-KN38080		İRTU-KN48080	
100x60 mm	24	İRTU-KN30060		İRTU-KN40060	

Delikli Kablo Kanalı Kapakları

Slotted Cable Trunking Cover



Ölçü / Size	Ambalaj Miktarı / Packing Qty. (mt)	Kod / Code	B. Fiyat / Unit Price (₺/mt)	Kod / Code	Halojen Free B. Fiyat / Unit Price (₺/mt)
25 mm	140	İRTU-KN5001		İRTU-KN6001	
40 mm	80	İRTU-KN5002		İRTU-KN6002	
60 mm	50	İRTU-KN5003		İRTU-KN6003	
80 mm	50	İRTU-KN5004		İRTU-KN6004	
100 mm	40	İRTU-KN5005		İRTU-KN6005	

IP-68 Polyamid Kablo Rakoru
IP-68 Polyamide Cable Gland

Kod / Code	Ölçü / Size	Renk / Color	Montaj Çapı / Mounting Diameter (mm)	Kutu Adedi / Box Qty.	Birim Fiyatı / Unit Price (Adet/pcs)
İRTU-K1007	PG-7	■ ■	12,5	450	📄
İRTU-K1009	PG-9	■ ■	15,5	300	📄
İRTU-K1011	PG-11	■ ■	18,5	200	📄
İRTU-K1013	PG-13,5	■ ■	20,5	175	📄
İRTU-K1016	PG-16	■ ■	22,5	125	📄
İRTU-K1021	PG-21	■ ■	28,5	75	📄
İRTU-K1029	PG-29	■ ■	37,5	40	📄
İRTU-K1036	PG-36	■ ■	47,5	20	📄
İRTU-K1042	PG-42	■ ■	55	15	📄
İRTU-K1048	PG-48	■ ■	60	12	📄
İRTU-K2012	M12X1,5	■ ■	12	450	📄
İRTU-K2016	M16X1,5	■ ■	16	200	📄
İRTU-K2020	M20X1,5	■ ■	20	150	📄
İRTU-K2025	M25X1,5	■ ■	25	75	📄
İRTU-K2032	M32X1,5	■ ■	32	40	📄
İRTU-K2040	M40X1,5	■ ■	40	20	📄



Pirinç Kablo Rakoru IP68 (Nikel Kaplı)
Brass Cable Gland (Nickel Plated)

PG Kod / PG Code	Dış Ölçüsü / Size	Kablo Çapı / Cable Diameter (Min-Max) mm	Koli Adedi / Box Qty	Birim Fiyat / Unit Price (Adet/pcs)	Metrik Kod / Metric Code	Dış Ölçüsü / Size	Birim Fiyat / Unit Price (Adet/pcs)
İRTU-K3007	PG7	3,0 - 6,5	50	📄	İRTU-K4012	M12x1,5	📄
İRTU-K3009	PG9	4,0 - 8,0	50	📄	İRTU-K4016	M16x1,5	📄
İRTU-K3011	PG11	5,0 - 10,0	50	📄			
İRTU-K3013	PG13,5	6,0 - 12,0	50	📄	İRTU-K4020	M20x1,5	📄
İRTU-K3016	PG16	10,0 - 14,0	25	📄	İRTU-K4025	M25x1,5	📄
İRTU-K3021	PG21	13,0 - 18,0	25	📄	İRTU-K4032	M32x1,5	📄
İRTU-K3025	PG25	14,0 - 26,0	25	📄			
İRTU-K3029	PG29	18,0 - 25,0	20	📄	İRTU-K4040	M40x1,5	📄
İRTU-K3036	PG36	22,0 - 32,0	10	📄	İRTU-K4050	M50x1,5	📄
İRTU-K3042	PG42	30,0 - 38,0	10	📄			
İRTU-K3048	PG48	34,0-44,0	10	📄	İRTU-K4063	M63x1,5	📄



Kelepçeli Pirinç Rakor IP55
Brass Cable Gland with Clamp IP55

Kod Code	Dış Ölçüsü / Size	Kablo Çapı / Cable Diameter (Min-Max) mm	Koli Adedi / Box Qty	Birim Fiyat / Unit Price (Adet/pcs)
İRTU-K6007	PG7	3,0 - 6,0	100	📄
İRTU-K6009	PG9	6,0 - 9,0	100	📄
İRTU-K6011	PG11	7,0 - 10,0	100	📄
İRTU-K6013	PG13,5	8,0 - 12,0	100	📄
İRTU-K6016	PG16	10,0 - 14,0	100	📄
İRTU-K6021	PG21	14,0 - 20,0	100	📄
İRTU-K6025	PG25	20,0 - 24,0	100	📄
İRTU-K6029	PG29	24,0 - 29,0	50	📄
İRTU-K6036	PG36	30,0 - 35,0	50	📄
İRTU-K6042	PG42	35,0 - 40,0	10	📄
İRTU-K6048	PG48	40,0 - 45,0	10	📄
İRTU-K6055	PG55	43,0 - 49,0	10	📄



Pirinç Kablo Rakoru IP55
Brass Cable Gland IP55

Kod / Code	Dış Ölçüsü / Size	Kablo Çapı / Cable Diameter (Min-Max) mm	Koli Adedi / Box Qty	Birim Fiyat / Unit Price (Adet/pcs)
İRTU-K5007	PG7	3,0 - 6,0	100	📄
İRTU-K5009	PG9	6,0 - 9,0	100	📄
İRTU-K5011	PG11	7,0 - 10,0	100	📄
İRTU-K5013	PG13,5	8,0 - 12,0	100	📄
İRTU-K5016	PG16	10,0 - 14,0	100	📄
İRTU-K5021	PG21	14,0 - 20,0	100	📄
İRTU-K5025	PG25	20,0 - 24,0	100	📄
İRTU-K5029	PG29	24,0 - 29,0	50	📄
İRTU-K5036	PG36	30,0 - 35,0	50	📄
İRTU-K5042	PG42	35,0 - 40,0	10	📄
İRTU-K5048	PG48	40,0 - 45,0	10	📄
İRTU-K5055	PG55	43,0 - 49,0	10	📄

PG Polyamid Somun
PG Polyamide Nuts

Metrik Polyamid Somun
Metric Polyamide Nuts



Kod / Code	Ölçü / Size	Kutu Adedi / Box Qty.	Birim Fiyatı Unit Price (Adet/pcs)
İRTU-PS1007	PG-7	250	
İRTU-PS1009	PG-9	250	
İRTU-PS1011	PG-11	250	
İRTU-PS1013	PG-13,5	250	
İRTU-PS1016	PG-16	250	
İRTU-PS1021	PG-21	250	
İRTU-PS1029	PG-29	150	
İRTU-PS1036	PG-36	100	
İRTU-PS1042	PG-42	100	

Kod / Code	Ölçü / Size	Kutu Adedi / Box Qty.	Birim Fiyatı Unit Price (Adet/pcs)
İRTU-PS2012	M12X1,5	250	
İRTU-PS2016	M16X1,5	250	
İRTU-PS2020	M20X1,5	250	
İRTU-PS2025	M25X1,5	250	
İRTU-PS2032	M32X1,5	250	
İRTU-PS2040	M40X1,5	250	

PG Pirinç Nikel Kaplı Somun
Metal Nut Nickel Plated PG Size

Metrik Pirinç Nikel Kaplı Somun
Metal Nut Nickel Plated Metric Size



Kod / Code	Ölçüsü / Size	Ambalaj Miktarı Packing Qty	Birim Fiyatı Unit Price (Adet/pcs)
İRTU-PS3009	PG9	100	
İRTU-PS3011	PG11	100	
İRTU-PS3013	PG13,5	100	
İRTU-PS3016	PG16	100	
İRTU-PS3021	PG21	100	
İRTU-PS3025	PG25	50	
İRTU-PS3029	PG29	50	
İRTU-PS3036	PG36	25	
İRTU-PS3042	PG42	10	
İRTU-PS3048	PG48	10	

Kod / Code	Ölçüsü / Size	Ambalaj Miktarı Packing Qty	Birim Fiyatı Unit Price (Adet/pcs)
İRTU-PS4012	M12x1,5	100	
İRTU-PS4016	M16x1,5	100	
İRTU-PS4020	M20x1,5	100	
İRTU-PS4025	M25x1,5	100	
İRTU-PS4032	M32x1,5	50	
İRTU-PS4040	M40x1,5	50	
İRTU-PS4050	M50x1,5	10	
İRTU-PS4063	M63x1,5	10	

PG Pirinç Körtapa Nikel Kaplı Somun
Pg Metal Blind Stop Nickel Plated

Metrik Pirinç Nikel Kaplı Somun
Metric Metal Lock Nut Nickel Plated



Kod / Code	Ölçüsü / Size	Ambalaj Miktarı Packing Qty	Birim Fiyatı Unit Price (Adet/pcs)
İRTU-KT2009	PG9	50	
İRTU-KT2011	PG11	50	
İRTU-KT2013	PG13,5	50	
İRTU-KT2016	PG16	50	
İRTU-KT2021	PG21	50	
İRTU-KT2025	PG25	50	
İRTU-KT2029	PG29	50	
İRTU-KT2036	PG36	50	
İRTU-KT2042	PG42	50	
İRTU-KT2048	PG48	50	

Kod / Code	Ölçüsü / Size	Ambalaj Miktarı Packing Qty	Birim Fiyatı Unit Price (Adet/pcs)
İRTU-KT3012	M12x1,5	50	
İRTU-KT3016	M16x1,5	50	
İRTU-KT3020	M20x1,5	50	
İRTU-KT3025	M25x1,5	50	
İRTU-KT3032	M32x1,5	50	
İRTU-KT3040	M40x1,5	50	
İRTU-KT3050	M50x1,5	50	
İRTU-KT3063	M63x1,5	50	

Çelik Spiral Boru / Steel Spiral Pipe



STANDART



PVC KAPLI

Standart Kod / Code	İç Çap / Inside Diameter (mm)	NPT Ölçü / NPT Dimensions	Ambalaj Miktarı / Packing Qty. (mt)	Standart Birim Fiyat / Unit Price (\$ / mt)	PVC Kaplı Kod / Code	PVC Kaplı Birim Fiyat / Unit Price (\$ / mt)
İRTU-CGS09	9	1/4"	50		İRTU-PGS09	
İRTU-CGS11	11	3/8"	50		İRTU-PGS11	
İRTU-CGS14	14		50		İRTU-PGS14	
İRTU-CGS16	16	1/2"	50		İRTU-PGS16	
İRTU-CGS18	18		50		İRTU-PGS18	
İRTU-CGS21	21	3/4"	50		İRTU-PGS21	
İRTU-CGS26	26	1"	25		İRTU-PGS26	
İRTU-CGS29	29		25		İRTU-PGS29	
İRTU-CGS32	32		25		İRTU-PGS32	
İRTU-CGS35	35	1 1/4"	25		İRTU-PGS35	
İRTU-CGS37	37		25		İRTU-PGS37	
İRTU-CGS40	40	1 1/2"	25		İRTU-PGS40	
İRTU-CGS42	42		25		İRTU-PGS42	
İRTU-CGS45	45		25		İRTU-PGS45	
İRTU-CGS50	50	2"	25		İRTU-PGS50	

Çelik Spiral Boru Kılavuz Telli Steel Spiral Pipe with Wire



STANDART



PVC KAPLI

Standart Kod / Code	İç Çap / Inside Diameter (mm)	NPT Ölçü / NPT Dimensions	Ambalaj Miktarı / Packing Qty. (mt)	Standart Birim Fiyat / Unit Price (\$ / mt)	PVC Kaplı Kod / Code	PVC Kaplı Kod / Code
İRTU-PGS211	11	3/8"	50		İRTU-CGS211	
İRTU-PGS214	14		50		İRTU-CGS214	
İRTU-PGS216	16	1/2"	50		İRTU-CGS216	
İRTU-PGS218	18		50		İRTU-CGS218	
İRTU-PGS221	21	3/4"	50		İRTU-CGS221	
İRTU-PGS226	26	1"	25		İRTU-CGS226	
İRTU-PGS229	29		25		İRTU-CGS229	
İRTU-PGS232	32		25		İRTU-CGS232	
İRTU-PGS235	35	1 1/4"	25		İRTU-CGS235	
İRTU-PGS237	37		25		İRTU-CGS237	

Çelik Tel Örgülü Spiral Boru Steel Wire Braided Spiral Pipe



STANDART



PVC KAPLI

Standart Kod / Code	Anma Ölçüsü / Size	İç Çap / Inside Diameter (mm)	Dış Çap / Outer Diameter (mm)	Ambalaj Miktarı / Packing Qty. (mt)	Standart Birim Fiyat / Unit Price (\$ / mt)	PVC Kaplı Kod / Code	PVC Kaplı Birim Fiyat / Unit Price (\$ / mt)
İRTU-CTS09	1/4"	10,0	16,0	50		İRTU-PTS09	
İRTU-CTS12	3/8"	12,0	16,0	50		İRTU-PTS12	
İRTU-CTS16	1/2"	15,5	19,0	50		İRTU-PTS16	
İRTU-CTS21	3/4"	20,5	27,0	50		İRTU-PTS21	
İRTU-CTS27	1"	26,5	35,0	25		İRTU-PTS27	
İRTU-CTS35	1 1/4"	34,5	42,0	25		İRTU-PTS35	
İRTU-CTS40	1 1/2"	39,5	48,0	25		İRTU-PTS40	
İRTU-CTS50	2"	50,5	60,0	25		İRTU-PTS50	

PVC Kaplı Galvaniz Çelik Spiral Boru Ağır Hizmet Tipi PVC Coated Galvanised Steel Spiral Pipe Heavy Duty



Kod / Code	Anma Ölçüsü / Size	İç Çap / Inside Diameter (mm)	Dış Çap / Outer Diameter (mm)	Ambalaj Miktarı / Packing Qty. (mt)	Birim Fiyat / Unit Price (\$ / mt)
İRTU-EF10	1/4"	10,0	15,0	30	
İRTU-EF12	3/8"	12,0	18,0	30	
İRTU-EF16	1/2"	15,5	21,5	30	
İRTU-EF21	3/4"	20,5	27,0	30	
İRTU-EF27	1"	26,5	33,0	30	
İRTU-EF35	1 1/4"	34,5	43,0	15	
İRTU-EF40	1 1/2"	39,5	48,0	15	
İRTU-EF50	2"	50,5	60,0	15	
İRTU-EF65	2 1/2"	65,0	72,0	7,5	
İRTU-EF75	3"	75,0	87,0	7,5	

Galvaniz Çelik Liquiditte Spiral Boru Rakoru (Erkek Tip) IP68
Galvanised Steel Liquiditte Spiral Pipe Gland (Male Type) IP68



Kod / Code	PG Serisi PG Series	Birim Fiyat Unit Price (Adet/Pcs)	Kod / Code	Metrik Serisi Metric Series	Birim Fiyat Unit Price (Adet/Pcs)	Kod / Code	NPT Serisi NPT Series	Spiral Ölç. Size	Birim Fiyat Unit Price (Adet/Pcs)
İRTU-GSPRG11	PG11		İRTU-GSRM16	M16 x 1,5		İRTU-GSNPT038	3/8"	3/8"	
İRTU-GSPRG13,5	PG13,5		İRTU-GSRM20	M20 x 1,5		İRTU-GSNPT012	1/2"	1/2"	
İRTU-GSPRG21	PG21		İRTU-GSRM25	M25 x 1,5		İRTU-GSNPT034	3/4"	1/2"	
İRTU-GSPRG29	PG29		İRTU-GSRM32	M32 x 1,5		İRTU-GSNPT100	1"	1"	
İRTU-GSPRG36	PG36		İRTU-GSRM40	M40 x 1,5		İRTU-GSNPT114	1 1/4"	1 1/4"	
İRTU-GSPRG42	PG42		İRTU-GSRM50	M50 x 1,5		İRTU-GSNPT112	1 1/2"	1 1/2"	
İRTU-GSPRG48	PG48		İRTU-GSRM63	M63 x 1,5		İRTU-GSNPT200	2"	2"	

Pirinç Nikel Kaplı Sabit Tip Spiral Rakoru IP54
Nickel Plated Brass Spiral Gland Fixed Type IP54



Kod / Code	PG Serisi PG Series	Spiral Ölç. Size	Birim Fiyat Unit Price (Adet/Pcs)	Kod / Code	Metrik Serisi Metric Series	Spiral Ölç. Size	Birim Fiyat Unit Price (Adet/Pcs)	Kod / Code	NPT	Spiral Ölç. Size	Birim Fiyat Unit Price (Adet/Pcs)
İRTU-SPR11	PG11	PG11		İRSMR-16	M16 x 1,5	3/8"		İRNSR-12	3/8"	3/8"	
İRTU-SPR13	PG13,5	PG13,5		İRSMR-20	M20 x 1,5	1/2"		İRNSR-12S	1/2"	1/2"	
İRTU-SPR21	PG21	PG21		İRSMR-25	M25 x 1,5	3/4"		İRNSR-34	3/4"	3/4"	
İRTU-SPR29	PG29	PG29		İRSMR-32	M32 x 1,5	1"		İRNSR-100	1"	1"	
İRTU-SPR36	PG36	PG36		İRSMR-40	M40 x 1,5	1 1/4"		İRNSR-114	1 1/4"	1 1/4"	
İRTU-SPR42	PG42	PG42		İRSMR-50	M50 x 1,5	1 1/2"		İRNSR-112	1 1/2"	1 1/2"	
İRTU-SPR48	PG48	PG48		İRSMR-63	M63 x 1,5	2"		İRNSR-200	2"	2"	
								İRNSR-212	2 1/2"	2 1/2"	
								İRNSR-300	3"	3"	
								İRNSR-400	4"	4"	

Pirinç Nikel Kaplı Boru Rakoru Erkek Tip - Ağır Hizmet (IP68)
Nickel Plated Brass Spiral Gland Male Type - Heavy Duty IP68



Kod / Code	PG Serisi PG Series	Spiral Ölç. Size	Birim Fiyat Unit Price (Adet/Pcs)	Kod / Code	Metrik Serisi Metric Series	Spiral Ölç. Size	Birim Fiyat Unit Price (Adet/Pcs)	Kod / Code	NPT	Spiral Ölç. Size	Birim Fiyat Unit Price (Adet/Pcs)
İRTU-BBFP09	PG9	PG9		İRTU-BBFM16	M16 x 1,5	1/4"		İRTU-BBFN01	1/4"	1/4"	
İRTU-BBFP11	PG11	PG11		İRTU-BBFM16	M16 x 1,5	3/8"		İRTU-BBFN02	3/8"	3/8"	
İRTU-BBFP14	PG13,5	PG16		İRTU-BBFM20	M16 x 1,5	1/2"		İRTU-BBFN03	1/2"	1/2"	
İRTU-BBFP16	PG16	PG16		İRTU-BBFM25	M25 x 1,5	1"		İRTU-BBFN04	3/4"	3/4"	
İRTU-BBFP21	PG21	PG21		İRTU-BBFM32	M32 x 1,5	1 1/4"		İRTU-BBFN05	1"	1"	
İRTU-BBFP29	PG29	PG29		İRTU-BBFM40	M40 x 1,5	1 1/4"		İRTU-BBFN06	1 1/4"	1"	
İRTU-BBFP36	PG36	PG36		İRTU-BBFM50	M50 x 1,5	1 1/2"		İRTU-BBFN07	1 1/2"	1 1/4"	
İRTU-BBFP42	PG42	PG42		İRTU-BBFM63	M63 x 1,5	2"		İRTU-BBFN08	2"	2"	
İRTU-BBFP48	PG48	PG48									

AKIM TRAFOLARI



BARA GEİŞLİ
TRAFOLAR



KENDİNDEN BARALI
TRAFOLAR



KENDİNDEN KLEMENSLİ
TRAFOLAR



KABLO GEİŞLİ
TRAFOLAR



AILABİLİR
TRAFOLAR

UN-311

UN-312

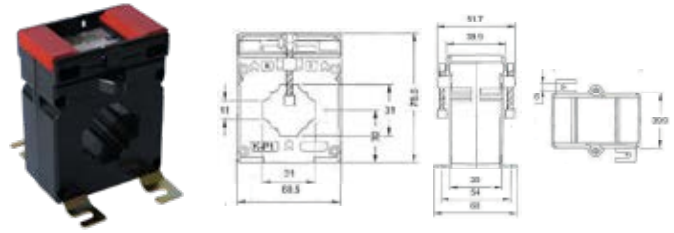
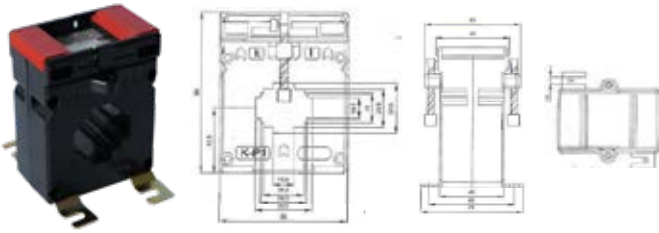

Akım / Primacy / Secondary	Ölçme Sınıfı /	Güç (VA)	Birim Fiyat Unit Price (Adet/pcs)
20/5 - 25/5 - 30/5 - 40/5 - 50/5 - 60/5 75/5 - 80/5 100/5 - 125/5 - 150/5 - 200/5 - 250/5 300/5 - 400/5 - 500/5 - 600/5	0,5 - 0,5S 1-3	1 1,5 2,5 5	☎
20/1 - 25/1 - 30/1 - 40/1 - 50/1 - 60/1 75/1 - 80/1 100/1 - 125/1 - 150/1 - 200/1 - 250/1 300/1 - 400/1 - 500/1 - 600/1	0,5 - 0,5S 1-3	1 1,5 2,5 5	

Akım / Primacy / Secondary	Ölçme Sınıfı /	Güç (VA)	Birim Fiyat Unit Price (Adet/pcs)
20/5 - 25/5 - 30/5 - 40/5 - 50/5 - 60/5 75/5 - 80/5 100/5 - 125/5 - 150/5 - 200/5 - 250/5 300/5 - 400/5 - 500/5 - 600/5	0,5 - 0,5S 1-3	1 1,5 2,5 5	☎
20/1 - 25/1 - 30/1 - 40/1 - 50/1 - 60/1 75/1 - 80/1 100/1 - 125/1 - 150/1 - 200/1 - 250/1 300/1 - 400/1 - 500/1 - 600/1	0,5 - 0,5S 1-3	1 1,5 2,5 5	

UN-410

UN-411

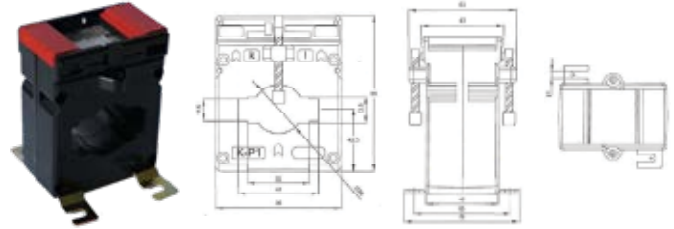
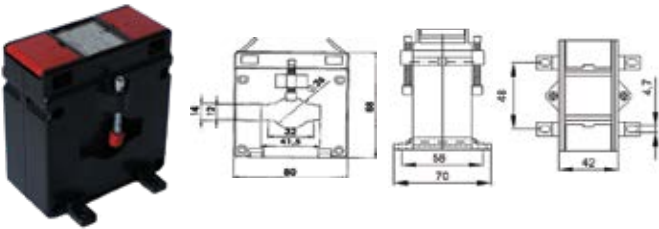

Akım / Primacy / Secondary	Ölçme Sınıfı /	Güç (VA)	Birim Fiyat Unit Price (Adet/pcs)
75/5 - 80/5 - 100/5 - 125/5 - 150/5 200/5 - 250/5 - 300/5 - 400/5 - 500/5 600/5 - 700/5 750/5 - 800/5	0,2 - 0,5 0,5S 1-3	1-1,25-1,5 2,5-5-10 15-20-30	☎
75/1 - 80/1 - 100/1 - 125/1 - 150/1 200/1 - 250/1 - 300/1 - 400/1 - 500/1 600/1 - 700/1 - 750/1 - 800/1	0,2 - 0,5 0,5S 1-3	1-1,25-1,5 2,5-5-10 15-20-30	

Akım / Primacy / Secondary	Ölçme Sınıfı /	Güç (VA)	Birim Fiyat Unit Price (Adet/pcs)
40/5 - 50/5 - 60/5 - 75/5 - 80/5 - 100/5 125/5 - 150/5 - 200/5 - 250/5 - 300/5 400/5 - 500/5 - 600/5 - 700/5 - 750/5 800/5	0,2 - 0,5 0,5S 1-3	1-1,25-1,5 2,5-5-10 15-20-30	☎
40/1 - 50/1 - 60/1 - 75/1 - 80/1 - 100/1 125/1 - 150/1 - 200/1 - 250/1 - 300/1 400/1 - 500/1 - 600/1 - 700/1 - 750/1 - 800/1	0,2 - 0,5 0,5S 1-3	1-1,25-1,5 2,5-5-10 15-20-30	

UN-412

UN-510

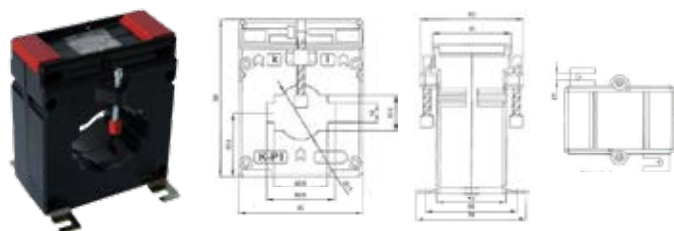
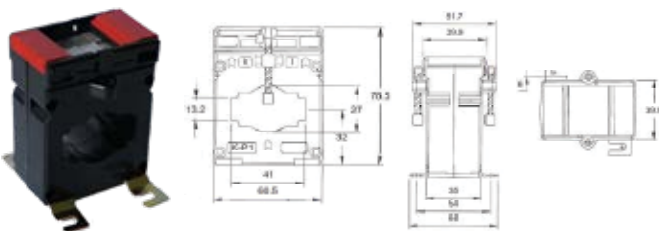

Akım / Primacy / Secondary	Ölçme Sınıfı /	Güç (VA)	Birim Fiyat Unit Price (Adet/pcs)
50/5 - 60/5 - 75/5 - 80/5 100/5 - 125/5 150/5 - 200/5 - 250/5 300/5 - 400/5 500/5 - 600/5 - 700/5 - 750/5 - 800/5	0,2 - 0,5 0,5S 1-3	1 - 1,5 2,5 - 5 10 - 15	☎
50/1 - 60/1 - 75/1 - 80/1 100/1 - 125/1 150/1 - 200/1 - 250/1 300/1 - 400/1 500/1 - 600/1 - 700/1 - 750/1 - 800/1	0,2 - 0,5 0,5S 1-3	1 - 1,5 2,5 - 5 10 - 15	

Akım / Primacy / Secondary	Ölçme Sınıfı /	Güç (VA)	Birim Fiyat Unit Price (Adet/pcs)
150/5 - 200/5 - 250/5 - 300/5 - 400/5 500/5 - 600/5 - 700/5 - 750/5 - 800/5 1000/5 - 1200/5 - 1250/5	0,2 - 0,5 0,5S 1-3	1-1,25-1,5 2,5-5-10 15-20-30	☎
150/1 - 200/1 - 250/1 - 300/1 - 400/1 500/1 - 600/1 - 700/1 - 750/1 - 800/1 1000/1 - 1200/1 - 1250/1	0,2 - 0,5 0,5S 1-3	1-1,25-1,5 2,5-5-10 15-20-30	

UN-530

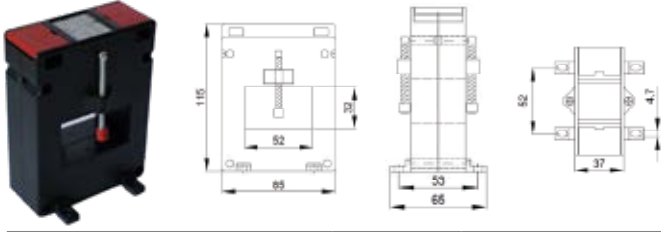

Akım / Primacy / Secondary	Ölçme Sınıfı /	Güç (VA)	Birim Fiyat Unit Price (Adet/pcs)
200/5 - 250/5 - 300/5 - 400/5 - 500/5 600/5 - 700/5 - 750/5 - 800/5 - 1000/5 1200/5-1250/5-1500/5-1600/5-2000/5	0,2 - 0,5 0,5S 1-3	1-1,25-1,5 2,5-5-10 15-20-30	Ⓢ
200/1 - 250/1 - 300/1 - 400/1 - 500/1 600/1 - 700/1 - 750/1 - 800/1 - 1000/1 1200/1-1250/1-1500/1-1600/1-2000/1	0,2 - 0,5 0,5S 1-3	1-1,25-1,5 2,5-5-10 15-20-30	

UN-610

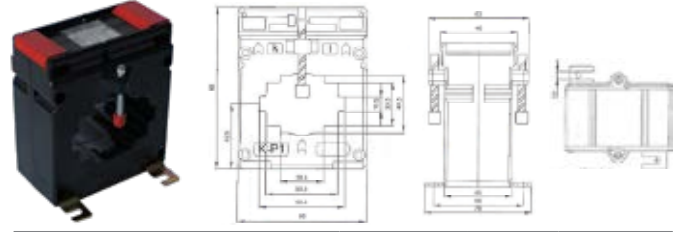

Akım / Primacy / Secondary	Ölçme Sınıfı /	Güç (VA)	Birim Fiyat Unit Price (Adet/pcs)
150/5 - 200/5 - 250/5 - 300/5 - 400/5 500/5 - 600/5 - 700/5 - 750/5 - 800/5 1000/5 - 1200/5 - 1250/5	0,2 - 0,2S 0,5 - 0,5S 1-3	1-1,25-1,5 2,5-5-10 15-20-30	Ⓢ
150/1 - 200/1 - 250/1 - 300/1 - 400/1 500/1 - 600/1 - 700/1 - 750/1 - 800/1 1000/1 - 1200/1 - 1250/1	0,2 - 0,5 0,5S 1-3	1-1,25-1,5 2,5-5-10 15-20-30	

UN-630

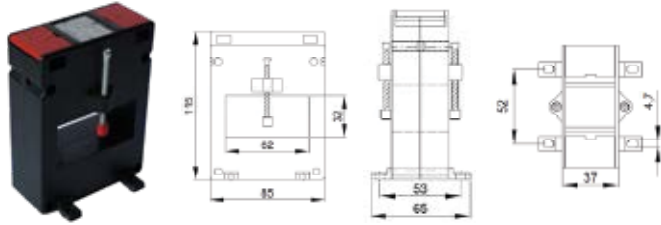

Akım / Primacy / Secondary	Ölçme Sınıfı /	Güç (VA)	Birim Fiyat Unit Price (Adet/pcs)
200/5 - 250/5 - 300/5 - 400/5 - 500/5 600/5 - 700/5 - 750/5 - 800/5 - 1000/5 1200/5-1250/5-1500/5-1600/5-2000/5	0,2 - 0,2S 0,5 - 0,5S 1-3	1-1,25-1,5 2,5-5-10 15-20-30	Ⓢ
200/1 - 250/1 - 300/1 - 400/1 - 500/1 600/1 - 700/1 - 750/1 - 800/1 - 1000/1 1200/1-1250/1-1500/1-1600/1-2000/1	0,2 - 0,2S 0,5 - 0,5S 1-3	1-1,25-1,5 2,5-5-10 15-20-30	

UN-130

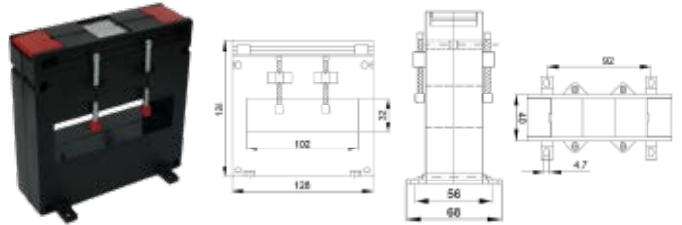

Akım / Primacy / Secondary	Ölçme Sınıfı /	Güç (VA)	Birim Fiyat Unit Price (Adet/pcs)
400/5 - 500/5 600/5 - 700/5 - 750/5 800/5 - 1000/5 1200/5 - 1250/5 - 1500/5 1600/5 - 2000/5 - 2500/5 - 3000/5 3200/5 - 4000	0,2 - 0,2S 0,5 - 0,5S 1-3	1-1,25-1,5 2,5-5-10 15-20-30	Ⓢ
150/1 - 200/1 - 250/1 - 300/1 - 400/1 500/1 - 600/1 - 700/1 - 750/1 - 800/1 1000/1 - 1200/1 - 1250/1	0,2 - 0,5 0,5S 1-3	1-1,25-1,5 2,5-5-10 15-20-30	

UN-150

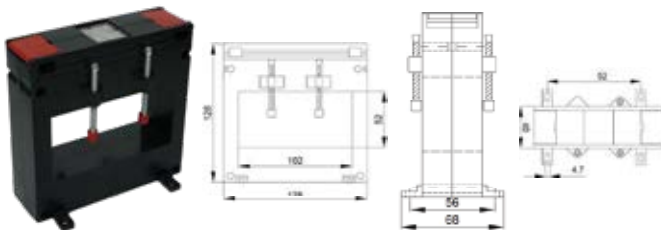

Akım / Primacy / Secondary	Ölçme Sınıfı /	Güç (VA)	Birim Fiyat Unit Price (Adet/pcs)
400/5 - 500/5 600/5 - 700/5 - 750/5 800/5 - 1000/5 1200/5 - 1250/5 - 1500/5 1600/5 - 2000/5 - 2500/5 - 3000/5 3200/5 - 4000	0,2 - 0,2S 0,5 - 0,5S 1-3	1-1,25-1,5 2,5-5-10 15-20-30	Ⓢ
150/1 - 200/1 - 250/1 - 300/1 - 400/1 500/1 - 600/1 - 700/1 - 750/1 - 800/1 1000/1 - 1200/1 - 1250/1	0,2 - 0,5 0,5S 1-3	1-1,25-1,5 2,5-5-10 15-20-30	

UN-125

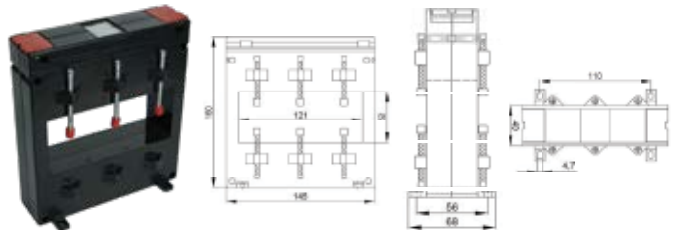

Akım / Primacy / Secondary	Ölçme Sınıfı /	Güç (VA)	Birim Fiyat Unit Price (Adet/pcs)
600/5 - 700/5 - 750/5 - 800/5 - 1000/5 1200/5 - 1250/5 - 1500/5 1600/5 2000/5 2500/5 - 3000/5 3200/5 4000/5 - 5000/5 - 6000/5	0,2 - 0,2S 0,5 - 0,5S 1-3	1-1,25-1,5 2,5-5-10 15-20-30	Ⓢ
600/1 - 700/1 - 750/1 - 800/1 - 1000/1 1200/1 - 1250/1 - 1500/1 1600/1 2000/1 - 2500/1 - 3000/1 3200/1 4000/1 - 5000/1 - 6000/1	0,2 - 0,2S 0,5 - 0,5S 1-3	1-1,25-1,5 2,5-5-10 15-20-30	

UN-127

UA-23

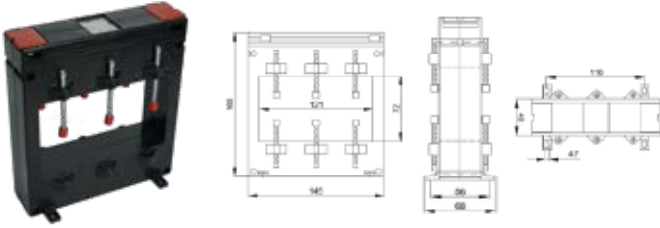

Akım / Primacy / Secondary	Ölçme Sınıfı /	Güç (VA)	Birim Fiyat Unit Price (Adet/pcs)
600/5 - 700/5 - 750/5 - 800/5 - 1000/5 1200/5 - 1250/5 - 1500/5 1600/5 2000/5 2500/5 - 3000/5 3200/5 4000/5 - 5000/5 - 6000/5	0,2 - 02S 0,5 - 0,5S 1-3	1-1,25-1,5 2,5-5-10 15-20-30	☎
600/1 - 700/1 - 750/1 - 800/1 - 1000/1 1200/1 - 1250/1 - 1500/1 1600/1 2000/1 - 2500/1 - 3000/1 3200/1 4000/1 - 5000/1 - 6000/1	0,2 - 02S 0,5 - 0,5S 1-3	1-1,25-1,5 2,5-5-10 15-20-30	

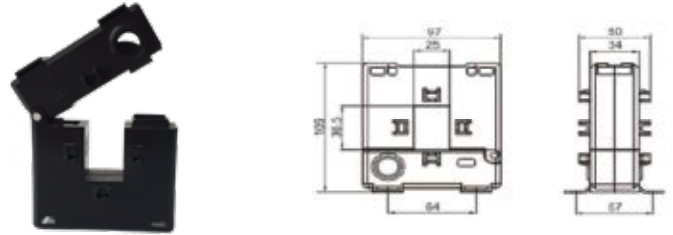

Akım / Primacy / Secondary	Ölçme Sınıfı /	Güç (VA)	Birim Fiyat Unit Price (Adet/pcs)
100/5 - 125/5 - 150/5 200/5 - 250/5 - 300/5 400/5	0,5 - 1 - 3	1,25-1,5 2,5-3,75 5	☎
100/1 - 125/1 - 150/1 200/1 - 250/1 - 300/1 400/1	0,5 - 1 - 3	1,25-1,5 2,5-3,75 5	

UA-58

UA-812

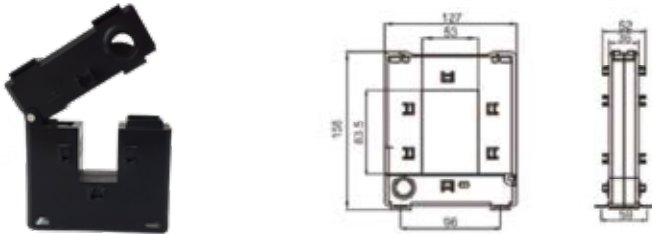

Akım / Primacy / Secondary	Ölçme Sınıfı /	Güç (VA)	Birim Fiyat Unit Price (Adet/pcs)
250/5 - 300/5 - 400/5 - 500/5 600/5 700/5 - 750/5 - 800/5 1000/5 1200/5	0,5 1 - 3	1-1,5-2,5 5 - 7,5 10 - 15	☎
250/1 - 300/1 - 400/1 - 500/1 600/1 700/1 - 750/1 - 800/1 1000/1 - 1200/1	0,5 1 - 3	1-1,5-2,5 5 - 7,5 10 - 15	

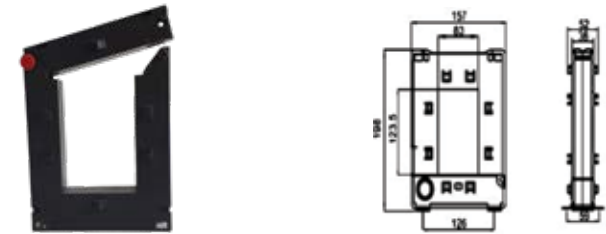

Akım / Primacy / Secondary	Ölçme Sınıfı /	Güç (VA)	Birim Fiyat Unit Price (Adet/pcs)
400/5 - 500/5 600/5 - 700/5 - 750/5 800/5 - 1000/5 1200/5 - 1250/5 - 1500/5 1600/5 - 2000/5 - 2500/5 - 3000/5 3200/5 - 4000/5	0,5 1 - 3	1,5 - 2,5 5-10 15 - 30	☎
400/1 - 500/1 - 600/1 - 700/1 - 750/1 800/1-1000/1-1200/1-1250/1-1500/1 1600/1 - 2000/1 - 2500/1 - 3000/1 3200/1 - 4000/1	0,5 1 - 3	1,5 - 2,5 5-10 15 - 30	

UNS-17

UNS-30

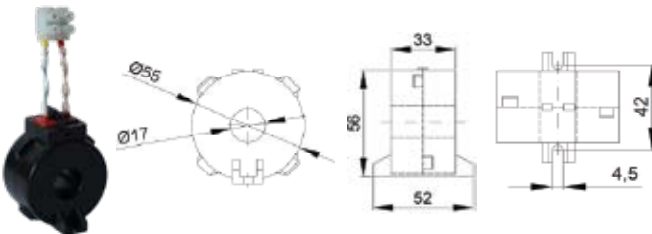

Akım / Primacy / Secondary	Ölçme Sınıfı /	Güç (VA)	Birim Fiyat Unit Price (Adet/pcs)
30/5 - 40/5 - 50/5 - 60/5 - 75/5 80/5 - 100/5 - 125/5 - 150/5	0,5 1 - 3	1,5 2,5 5	☎
30/1 - 40/1 - 50/1 - 60/1 - 75/1 80/1 - 100/1 - 125/1 - 150/1	0,5 1 - 3	1,5 2,5 5	

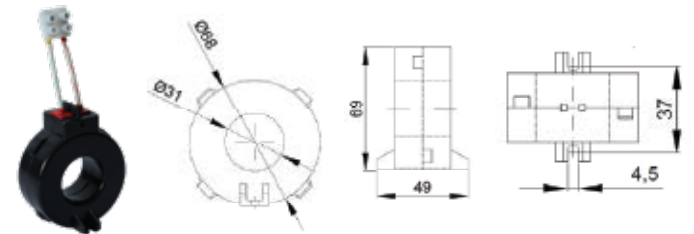

Akım / Primacy / Secondary	Ölçme Sınıfı /	Güç (VA)	Birim Fiyat Unit Price (Adet/pcs)
150/5 - 200/5 - 250/5 - 300/5 400/5 - 500/5 - 600/5 - 700/5 750/5 - 800/5	0,5 1 - 3	1,5 - 2,5 5 - 10 15	☎
150/1 - 200/1 - 250/1 - 300/1 400/1 - 500/1 - 600/1 - 700/1 750/1 - 800/1	0,5 1 - 3	1,5 - 2,5 5 - 10 15	

UNS-40

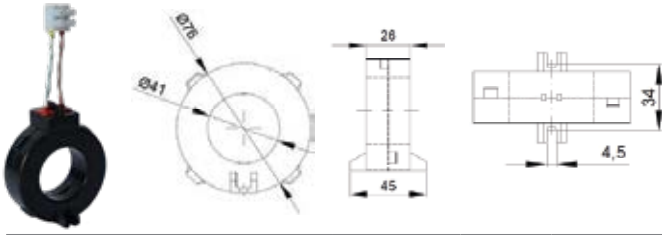

Akım / Primacy / Secondary	Ölçme Sınıfı /	Güç (VA)	Birim Fiyat Unit Price (Adet/pcs)
150/5 - 200/5 - 250/5 - 300/5 400/5 - 500/5 - 600/5 - 700/5 750/5 - 800/5	0,5 1 - 3	1,5 - 2,5 5 - 10 15	
150/1 - 200/1 - 250/1 - 300/1 400/1 - 500/1 - 600/1 - 700/1 750/1 - 800/1	0,5 1 - 3	1,5 - 2,5 5 - 10 15	

UNS-60

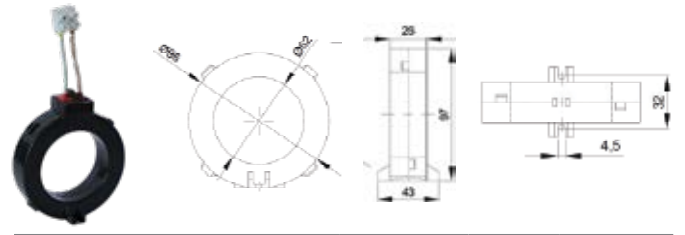

Akım / Primacy / Secondary	Ölçme Sınıfı /	Güç (VA)	Birim Fiyat Unit Price (Adet/pcs)
400/5 - 500/5 600/5 - 700/5 - 750/5 800/5 - 1000/5 1200/5 - 1250/5	0,5 1 - 3	1,5 - 2,5 5 - 10 15	
400/1 - 500/1 - 600/1 - 700/1 - 750/1 800/1-1000/1-1200/1-1250/1	0,5 1 - 3	1,5 - 2,5 5 - 10 15	

UNS-80

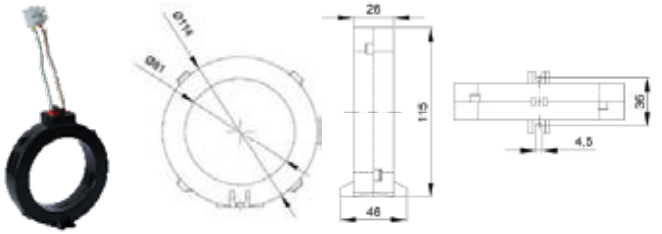

Akım / Primacy / Secondary	Ölçme Sınıfı /	Güç (VA)	Birim Fiyat Unit Price (Adet/pcs)
500/5 - 600/5 - 700/5 - 750/5 800/5 - 1000/5 - 1200/5 1250/5 - 1500/5 - 1600/5	0,5 1 - 3	5 10 15	
500/1 - 600/1 - 700/1 - 750/1 800/1 - 1000/1 - 1200/1 1250/1 - 1500/1 - 1600/1	0,5 1 - 3	5 10 15	

UNS-100

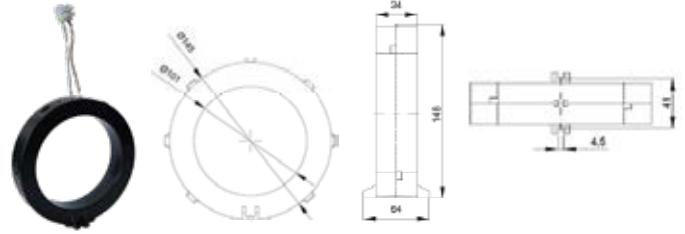

Akım / Primacy / Secondary	Ölçme Sınıfı /	Güç (VA)	Birim Fiyat Unit Price (Adet/pcs)
800/5 - 1000/5 - 1200/5 - 1250/5 1500/5 - 1600/5 - 2000/5 - 2500/5 3000/5 - 3200/5 - 4000/5	0,5 1 - 3	5 10 15	
800/1 - 1000/1 - 1200/1 - 1250/1 1500/1 - 1600/1 - 2000/1 - 2500/1 3000/1 - 3200/1 - 4000/1	0,5 1 - 3	5 10 15	

UNS-120

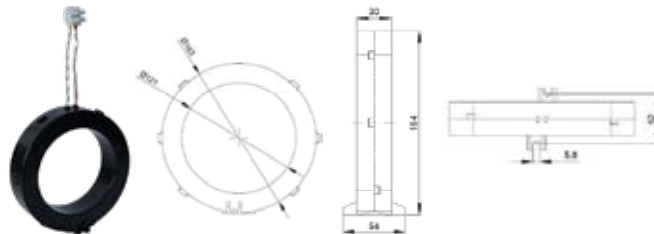

Akım / Primacy / Secondary	Ölçme Sınıfı /	Güç (VA)	Birim Fiyat Unit Price (Adet/pcs)
1000/5 - 1200/5 - 1250/5 - 1500/5 1600/5 - 2000/5 - 2500/5 3000/5 3200/5 4000/5	0,5 1 - 3	5-10 20-30	
1000/1 - 1200/1 - 1250/1 - 1500/1 1600/1 - 2000/1 - 2500/1 3000/1 - 3200/1 - 4000/1	0,5 1 - 3	1-1,25-1,5 2,5-5-10 15-20-30	

KLEMENSLER ve SİLİNDİRİK SİGORTALAR

SIRA KLEMENSLER



- Plastik Sıra Klemensler.
- Isıya Dayanıklı Klemensler.
- Yüksek Isıya Dayanıklı Klemensler.
- Şeffaf Polikarbon Klemensler.

SOKET KLEMENSLER



- 12'li Soket Klemens.
- İkili Modüler Sistem Klemensler.
- Üçlü Soket Klemens.
- 6'lı Klemens Bağlantı Soketi.

TRAFÖ STAATİT KLEMENSLER



- Steatit Klemensler.
- Kapaklı Terminal Klemensler.
- Trafo Klemensleri.
- Trafo Klemens Etiketleri.

BUAT KLEMENSLER



- Aç - Kapa Buat Klemensleri.
- Geçmeli Buat Klemensleri.
- Vidalı Yaylı Buat Klemensleri.
- Buat Kapama Parçası.
- Kulaklı Tip Vidalı Buat Klemensleri.

SİLİNDİRİK SİGORTALAR ve YUVALARI



- 10x38 Silindirik Sigortalar.
- 14x51 Silindirik Sigortalar.
- 22x58 Silindirik Sigortalar.
- Sigorta Yuvaları 1 Kutup
- Sigorta Yuvaları 2 Kutup
- Sigorta Yuvaları 3 Kutup

Plastik Sıra Klemensler, Vida Blokajlı - (Mavi)
Plastic Rear Terminals, Screw Blocked - (Blue)



Kod / Code	Cinsi / Type	Voltaj / Voltage (V)	Amper / Current (A)	Koli Adedi / Box Qty.	Adet Fiyat Unit Price (Adet/pcs)
İRTU-5000	No. 0 0.75 - 1.5 mm ² lik 12 Sıra/Poles	400	17.5	100	
İRTU-5001	No. 1 2.5 - 4 mm ² lik 12 Sıra/Poles	400	32	50	
İRTU-5002	No. 2 4 - 6 mm ² lik 12 Sıra/Poles	400	41	50	
İRTU-5003	No. 3 6 - 10 mm ² lik 10 Sıra/Poles	400	57	50	
İRTU-5004	No. 4 10 - 16 mm ² lik 6 Sıra/Poles	500	76	50	
İRTU-5005	No. 5 16 - 25 mm ² lik 6 Sıra/Poles	500	101	50	

Isıya Dayanıklı Plastik, Vida Blokajlı - (Beyaz-Kırmızı) V2, TSE, OSK
Heat-Resistant Plastic, Screw Blocked - (White-Red) V2, TSE, OSK



Kod / Code	Cinsi / Type	Voltaj / Voltage (V)	Amper Current (A)	Koli Adedi / Box Qty	Adet Fiyat Unit Price (Adet/pcs)
İRTU-5010	No. 0 0.75 - 1.5 mm ² lik 12 Sıra/Poles	400	17.5	100	
İRTU-5011	No. 1 2.5 - 4 mm ² lik 12 Sıra/Poles	400	32	50	
İRTU-5012	No. 2 4 - 6 mm ² lik 12 Sıra/Poles	400	41	50	
İRTU-5013	No. 3 6 - 10 mm ² lik 10 Sıra/Poles	400	57	50	
İRTU-5014	No. 4 10 - 16 mm ² lik 6 Sıra/Poles	500	76	50	
İRTU-5015	No. 5 16 - 25 mm ² lik 6 Sıra/Poles	500	101	50	
İRTU-5016	No. 3 3'lü 6 - 10 mm ² lik	400	57	50	

Isıya Dayanıklı Plastik, Vida Blokajlı - (Şeffaf-Polikarbon)
Heat Resistant Plastic, Screw Blocked - (Transparent-Polycarbon)



Kod / Code	Cinsi / Type	Voltaj / Voltage (V)	Amper / Current (A)	Koli Adedi / Box Qty	Adet Fiyat Unit Price (Adet/pcs)
İRTU-5020	No. 0 0.75 - 1.5 mm ² lik 12 Sıra/Poles	400	17.5	100	
İRTU-5021	No. 1 2.5 - 4 mm ² lik 12 Sıra/Poles	400	32	50	
İRTU-5022	No. 2 4 - 6 mm ² lik 12 Sıra/Poles	400	41	50	
İRTU-5023	No. 3 6 - 10 mm ² lik 10 Sıra/Poles	400	57	50	
İRTU-5024	No. 4 10 - 16 mm ² lik 6 Sıra/Poles	500	76	50	
İRTU-5025	No. 5 16 - 25 mm ² lik 6 Sıra/Poles	500	101	50	
İRTU-5026	No. 3 3'lü 6 - 10 mm ² lik	400	57	50	

Pano İçi Yüksek Isıya Dayanıklı, Vida Blokajlı - (200 °C HA66-VO)
In-Panel High Temperature Resistant, Screw Blocked - (200 °C HA66-VO)



Kod / Code	Cinsi / Type	Voltaj / Voltage (V)	Amper Current (A)	Koli Adedi / Box Qty	Adet Fiyat Unit Price (Adet/pcs)
İRTU-5029	No. 0 0.75 - 1.5 mm ² lik 12 Sıra/Poles	400	17.5	100	
İRTU-5030	No. 1 2.5 - 4 mm ² lik 12 Sıra/Poles	400	32	50	
İRTU-5031	No. 2 4 - 6 mm ² lik 12 Sıra/Poles	400	41	50	
İRTU-5032	No. 3 6 - 10 mm ² lik 10 Sıra/Poles	400	57	50	
İRTU-5033	No. 4 10 - 16 mm ² lik 6 Sıra/Poles	500	76	50	
İRTU-5034	No. 5 16 - 25 mm ² lik 6 Sıra/Poles	500	101	50	
İRTU-5035	No. 3 3'lü 6 - 10 mm ² lik	400	57	50	

Paletli Isıya Dayanıklı, Vida Blokajlı - (Beyaz-Kırmızı) 140 °C V2
Pallet Heat-Resistant, Screw-Blocked - (White-Red) 140 °C V2



Kod / Code	Cinsi / Type	Voltaj / Voltage (V)	Amper Current (A)	Koli Adedi / Box Qty	Adet Fiyat Unit Price (Adet/pcs)
İRTU-5040	No. 1 2.5 - 4 mm ² lik 12 Sıra/Poles	400	32	50	
İRTU-5041	No. 2 4 - 6 mm ² lik 12 Sıra/Poles	400	41	50	
İRTU-5042	No. 3 6 - 10 mm ² lik 10 Sıra/Poles	400	57	50	
İRTU-5043	No. 3 3'lü 6 - 10 mm ² lik	400	57	50	

Paletli Isıya Dayanıklı, Vida Blokajlı - (Şeffaf-Polikarbon)
Pallet Heat-Resistant, Screw-Blocked - (Transparent-Polycarbon)



Kod / Code	Cinsi / Type	Voltaj / Voltage (V)	Amper / Current (A)	Koli Adedi / Box Qty	Adet Fiyat / Unit Price (Adet/pcs)
İRTU-5050	No. 1 2.5 - 4 mm ² 'lik 12 Sıra/Poles	400	32	50	
İRTU-5051	No. 2 4 - 6 mm ² 'lik 12 Sıra/Poles	400	41	50	
İRTU-5052	No. 3 6 - 10 mm ² 'lik 10 Sıra/Poles	400	57	50	
İRTU-5053	No. 3 3'lü 6 - 10 mm ² 'lik	400	57	50	

Paletli Yüksek Isıya Dayanıklı, Vida Blokajlı - (200° C HA66-VO)
Pallet High Heat Resistant, Screw Blocked (200° C HA66-VO)



Kod / Code	Cinsi / Type	Voltaj / Voltage (V)	Amper / Current (A)	Koli Adedi / Box Qty	Adet Fiyat / Unit Price (Adet/pcs)
İRTU-5056	No. 1 2.5 - 4 mm ² 'lik 12 Sıra/Poles	400	32	50	
İRTU-5057	No. 2 4 - 6 mm ² 'lik 12 Sıra/Poles	400	41	50	
İRTU-5058	No. 3 6 - 10 mm ² 'lik 10 Sıra/Poles	400	57	50	
İRTU-5059	No. 3 3'lü 6 - 10 mm ² 'lik	400	57	50	

12' Li Soket Klemens
12 Socket Connector



Kod / Code	Cinsi / Type	Koli Adedi / Box Qty	Adet Fiyat / Unit Price (Adet/pcs)
İRTU-5060	No. 1-12'li 2.5 - 4 mm ² 'lik (Erkek Dişi Geçmeli Kilitli) Male - Female Telescopic Lock System	30	

2' Li Modüler Sistem Soket Klemensler
2 Pole Modular System Socket Connector



Kod / Code	Cinsi / Type	Koli Adedi / Box Qty	Adet Fiyat / Unit Price (Adet/pcs)
İRTU-5068	No. 1 - 2'li Soket Klemensi + Modüler Sistem No. 1 - 2'li Pole Socket Connector + Modular System	180	

3' Lü Soket Klemens
Trio Socket Connector



Kod / Code	Cinsi / Type	Koli Adedi / Box Qty	Adet Fiyat / Unit Price (Adet/pcs)
İRTU-5065	No.1 3'lü Soket Klemensi 3 Pole Socket Connector	100	
İRTU-5066	Soket Klemensi Kapağı (Takım) Plastic Cover Set	45	
İRTU-5067	No.1 3'lü Soket Klemensi+Kapak Takımı 3 Pole Socket Connector + Plastic Cover Set	45	

3' Lü Soket Klemens Bağlantı Aparatı
Trio Socket Connector Connection Apparatus



Kod / Code	Cinsi / Type	Koli Adedi / Box Qty	Adet Fiyat / Unit Price (Adet/pcs)
İRTU-5074	2.5 - 4 mm ² T Bağlantı Aparatı T Type Apparatus	60	

6' Lı Soket Klemens Bağlantı Aparatı
6' Socket Terminal Connection Device



Kod / Code	Renk / Color	Cinsi / Type	Koli Ad. / Box Qty	Adet Fiyat / Unit Price (Adet/pcs)
İRTU-5064	Beyaz / White	No:1, 2.5 - 4 mm ² 6'lı Soket Kapak Takım 6 Pole Socket+Plastic Cover Set	16	
İRTU-5063	Siyah / Black	No:1, 2.5 - 4 mm ² 6'lı Soket Kapak Takım 6 Pole Socket+Plastic Cover Set	16	

Trafo Klemensleri ve Etiketleri

Transformer Terminal Blocks and Labels



Kod / Code	Cinsi / Type	Voltaj / Voltage (V)	Amper / Current (A)	Koli Adedi / Box Qty	Adet Fiyat Unit Price (Adet/pcs)
İRTU-TK5135	1 x 4 mm2 Yüksek Tip 1 x 4 mm2 High Type	400	24	200	
İRTU-TK5136	2 x 4 mm2 Yüksek Tip 2 x 4 mm2 High Type	400	24	100	
İRTU-TK5137	1 x 6 mm2 Yüksek Tip 1 x 6 mm2 High Type	400	41	100	
İRTU-TK5139	Trafo Klemens Etik. Yazısız Transformer Terminals Sticker Printless			500	
İRTU-TK5140	Trafo Klemens Etik. Yazılı Transformer Terminals Sticker Printed			500	

Steatit Klemensler

Steatite Terminals



Kod / Code	Cinsi / Type	Koli Adedi / Box Qty	Adet Fiyat Unit Price (Adet/pcs)
İRTU-5081	No. 0 2'li Steatit Klemens / Steatite Terminal	150	
İRTU-5082	No. 1 2'li Steatit Klemens / Steatite Terminal	150	
İRTU-5083	No. 1 3'lü Steatit Klemens / Steatite Terminal	100	
İRTU-5084	No. 2 2'li Steatit Klemens / Steatite Terminal	100	
İRTU-5085	No. 2 3'lü Steatit Klemens / Steatite Terminal	50	
İRTU-5086	No. 3 2'li Steatit Klemens / Steatite Terminal	50	
İRTU-5087	No. 3 3'lü Steatit Klemens / Steatite Terminal	35	
İRTU-5088	No. 0 1'li Steatit Klemens / Steatite Terminal	400	
İRTU-5089	No. 1 1'li Steatit Klemens / Steatite Terminal	350	
İRTU-5090	No. 2 1'li Steatit Klemens / Steatite Terminal	200	
İRTU-5091	No. 3 1'li Steatit Klemens / Steatite Terminal	100	
İRTU-5093	No. 4 3'lü Steatit Klemens (Kondansatör için) Steatite Terminal (For Capacitor)	20	
İRTU-5094	No. 5 3'lü Steatit Klemens / Steatite Terminal	20	
İRTU-5095	No. 5 2'lü Steatit Klemens / Steatite Terminal	20	

Kapaklı Terminal Klemensler

LID Terminal Connectors



Kod / Code	Cinsi / Type	Koli Adedi / Box Qty	Adet Fiyat Unit Price (Adet/pcs)
İRTU - 5145	25 A 600V Terminal-3	50	
İRTU - 5146	25 A 600V Terminal-4	50	
İRTU - 5147	25 A 600V Terminal-6	50	
İRTU - 5148	25 A 600V Terminal-12	25	



Kod / Code	Ürün Tanımı / Product Name	Kablo Kesiti Cable Diameter	Kutu Adedi Box Qty	Birim Fiyat Unit Price (Adet/pcs)
İRTU-8840	2	0,14 - 4	100	
İRTU-8842	3		100	
İRTU-8843	4		100	
İRTU-8844	5		100	

Aç Kapa Buat Klemensi Push In Wire Connector

Geçmeli Buat Klemensi (Şeffaf - Renkli) Push-In Wire Connector (Transparent-Colourful)

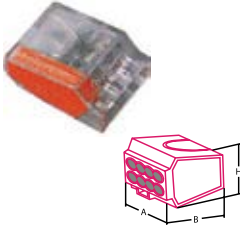

Kod / Code	Renk / Colo	Kutup Sayısı Pole Number	Kablo Kesiti Cable Diameter	A	B	C	Kutu Adedi Box Qty	Birim Fiyat Unit Price (Adet/pcs)
İRTU-PC352	Şeffaf/Transparent	2	2,5 mm ²	10,5	19,5	9,5	500	
İRTU-PC353	Şeffaf/Transparent	3	2,5 mm ²	13,5	19,7	9,5	500	
İRTU-PC354	Şeffaf/Transparent	4	2,5 mm ²	17,2	19,7	9,5	500	
İRTU-PC355	Şeffaf/Transparent	5	2,5 mm ²	21,1	19,7	9,5	500	
İRTU-PC356	Şeffaf/Transparent	6	2,5 mm ²	22	19,7	9,5	500	
İRTU-PC358	Şeffaf/Transparent	8	2,5 mm ²	17,5	19,0	16,8	250	

Vidalı Yaylı Buat Klemensleri Push in Wire Screw Connector

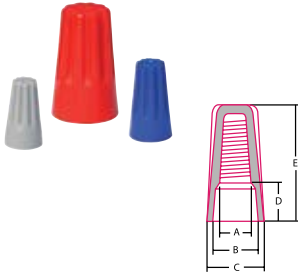

Kod / Code	Renk / Color	A	B	C	D	E	Kutu Adedi Box Qty	Birim Fiyat Unit Price (Adet/pcs)
İRTU-VKP1	Grey	3,80	6,70	8,60	5,80	15,20	500	
İRTU-VKP2	Blue	4,10	7,00	9,80	5,90	17,60	500	
İRTU-VKP3	Orange	5,00	9,90	12,20	7,80	22,00	500	
İRTU-VKP4	Yellow	6,00	11,20	14,00	7,90	24,00	250	
İRTU-VKP6	Red	7,50	13,00	16,40	9,15	26,50	100	

Kulaklı Tip Vidalı Buat Klemensi Screw-On Push in Wire Nut Connector

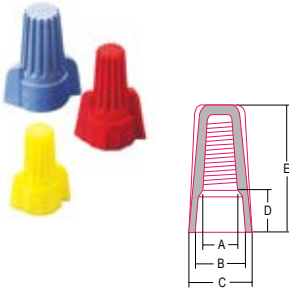

Kod / Code	Renk / Colo	A	B	C	D	E	Kutu Adedi Box Qty	Birim Fiyat Unit Price (Adet/pcs)
İRTU-VKPP1	Yellow	6,40	9,80	18,20	9,00	25,80	500	
İRTU-VKPP2	Orange	7,20	11,60	18,30	9,20	29,00	500	
İRTU-VKPP3	Red	9,00	13,50	23,00	9,60	31,80	500	
İRTU-VKPP4	Grey	10,00	14,90	25,50	10,00	33,30	250	
İRTU-VKPP6	Blue	12,00	18,80	32,00	13,00	40,00	100	

Kapama Parçası Closing Part

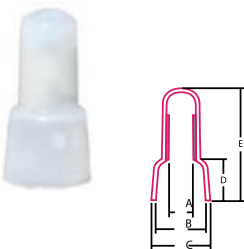

Kod / Code	A	B	C	D	E	Kutu Adedi Box Qty	Birim Fiyat Unit Price (Adet/pcs)
İRTU-CE01	2,6	6,2	7,8	6,2	18,0	1000	
İRTU-CE02	3,1	7,9	9,5	7,2	19,7	1000	
İRTU-CE05	4,1	10,50	12,5	9,6	25,5	1000	
İRTU-CE08	5,3	12,4	14,6	12,0	27,7	500	

Silindirik Kartuş Sigorta Yuvaları (10x38)
Cylindrical Cartridge Fuse Holders (10x38)



Kod / Code	Cinsi / Type	Kutu Adedi / Box Qty	Adet Fiyat Unit Price (Adet/pcs)
İRTU - KSY011038	1 Kutup 10X38 Silindirik Kartuş Sigorta Yuvası 1 Pole 10X38 Cylindrical Cartridge Fuse Holder	10	
İRTU - KSY021038	2 Kutup 10X38 Silindirik Kartuş Sigorta Yuvası 2 Pole 10X38 Cylindrical Cartridge Fuse Holder	8	
İRTU - KSY031038	3 Kutup 10X38 Silindirik Kartuş Sigorta Yuvası 3 Pole 10X38 Cylindrical Cartridge Fuse Holder	6	
İRTU - KSY041038	4 Kutup 10X38 Silindirik Kartuş Sigorta Yuvası 4 Pole 10X38 Cylindrical Cartridge Fuse Holder	4	
İRTU-KSY051038	1 Kutup 10X38 Ledli Silindirik Kartuş Sigorta Yuvası 1 Pole 10X38 Led Cylindrical Cartridge Fuse Holder	10	

Silindirik Kartuş Sigorta Yuvaları (14x51)
Cylindrical Cartridge Fuse Holders (14x51)



Kod / Code	Cinsi / Type	Kutu Adedi / Box Qty	Adet Fiyat Unit Price (Adet/pcs)
İRTU - KSY011451	1 Kutup 14X51 Silindirik Kartuş Sigorta Yuvası 1 Pole 14X51 Cylindrical Cartridge Fuse Holder	10	
İRTU - KSY021451	2 Kutup 14X51 Silindirik Kartuş Sigorta Yuvası 2 Pole 14X51 Cylindrical Cartridge Fuse Holder	8	
İRTU - KSY031451	3 Kutup 14X51 Silindirik Kartuş Sigorta Yuvası 3 Pole 14X51 Cylindrical Cartridge Fuse Holder	6	

Silindirik Kartuş Sigorta Yuvaları (22x58)
Cylindrical Cartridge Fuse Holders (22x58)



Kod / Code	Cinsi / Type	Kutu Adedi / Box Qty	Adet Fiyat Unit Price (Adet/pcs)
İRTU - KSY012258	1 Kutup 22X58 Silindirik Kartuş Sigorta Yuvası 1 Pole 22X58 Cylindrical Cartridge Fuse Holder	10	
İRTU - KSY022258	2 Kutup 22X58 Silindirik Kartuş Sigorta Yuvası 2 Pole 22X58 Cylindrical Cartridge Fuse Holder	8	
İRTU - KSY032258	3 Kutup 22X58 Silindirik Kartuş Sigorta Yuvası 3 Pole 22X58 Cylindrical Cartridge Fuse Holder	6	

Silindirik Kartuş Sigortaları (10x38)
Cylindrical Cartridge Fuses (10x38)

Kod / Code	Cinsi / Type	Kutu Adedi / Box Qty	Adet Fiyat Unit Price (Adet/pcs)
İRTU-KS1038005	10X38 Kartuş Sigorta Buşonu 0,5A / 10X38 Cylindrical Cartridge Fuse 0,5A	10	
İRTU-KS1038010	10X38 Kartuş Sigorta Buşonu 1A / 10X38 Cylindrical Cartridge Fuse 1A	10	
İRTU-KS1038020	10X38 Kartuş Sigorta Buşonu 2A / 10X38 Cylindrical Cartridge Fuse 2A	10	
İRTU-KS1038040	10X38 Kartuş Sigorta Buşonu 4A / 10X38 Cylindrical Cartridge Fuse 4A	10	
İRTU-KS1038060	10X38 Kartuş Sigorta Buşonu 6A / 10X38 Cylindrical Cartridge Fuse 6A	10	
İRTU-KS1038080	10X38 Kartuş Sigorta Buşonu 8A / 10X38 Cylindrical Cartridge Fuse 8A	10	
İRTU-KS1038100	10X38 Kartuş Sigorta Buşonu 10A / 10X38 Cylindrical Cartridge Fuse 10A	10	
İRTU-KS1038120	10X38 Kartuş Sigorta Buşonu 12A / 10X38 Cylindrical Cartridge Fuse 12A	10	
İRTU-KS1038160	10X38 Kartuş Sigorta Buşonu 16A / 10X38 Cylindrical Cartridge Fuse 16A	10	
İRTU-KS1038200	10X38 Kartuş Sigorta Buşonu 20A / 10X38 Cylindrical Cartridge Fuse 20A	10	
İRTU-KS1038250	10X38 Kartuş Sigorta Buşonu 25A / 10X38 Cylindrical Cartridge Fuse 25A	10	
İRTU-KS1038320	10X38 Kartuş Sigorta Buşonu 32A / 10X38 Cylindrical Cartridge Fuse 32A	10	



Silindirik Kartuş Sigortaları (14x51)
Cylindrical Cartridge Fuses (14x51)

Kod / Code	Cinsi / Type	Kutu Adedi / Box Qty	Adet Fiyat Unit Price (Adet/pcs)
İRTU-KS145106	14X51 Kartuş Sigorta Buşonu 6A / 14X51 Cylindrical Cartridge Fuse 6A	10	
İRTU-KS145108	14X51 Kartuş Sigorta Buşonu 8A / 14X51 Cylindrical Cartridge Fuse 8A	10	
İRTU-KS145110	14X51 Kartuş Sigorta Buşonu 10A / 14X51 Cylindrical Cartridge Fuse 10A	10	
İRTU-KS145112	14X51 Kartuş Sigorta Buşonu 12A / 14X51 Cylindrical Cartridge Fuse 12A	10	
İRTU-KS145116	14X51 Kartuş Sigorta Buşonu 16A / 14X51 Cylindrical Cartridge Fuse 16A	10	
İRTU-KS145120	14X51 Kartuş Sigorta Buşonu 20A / 14X51 Cylindrical Cartridge Fuse 20A	10	
İRTU-KS145125	14X51 Kartuş Sigorta Buşonu 25A / 14X51 Cylindrical Cartridge Fuse 25A	10	
İRTU-KS145132	14X51 Kartuş Sigorta Buşonu 32A / 14X51 Cylindrical Cartridge Fuse 32A	10	
İRTU-KS145140	14X51 Kartuş Sigorta Buşonu 40A / 14X51 Cylindrical Cartridge Fuse 40A	10	
İRTU-KS145150	14X51 Kartuş Sigorta Buşonu 50A / 14X51 Cylindrical Cartridge Fuse 50A	10	



Silindirik Kartuş Sigortaları (22x58)
Cylindrical Cartridge Fuses (22x58)

Kod / Code	Cinsi / Type	Kutu Adedi / Box Qty	Adet Fiyat Unit Price (Adet/pcs)
İRTU-KS2258016	22X58 Kartuş Sigorta Buşonu 16A / 22X58 Cylindrical Cartridge Fuse 16A	10	
İRTU-KS2258020	22X58 Kartuş Sigorta Buşonu 20A / 22X58 Cylindrical Cartridge Fuse 20A	10	
İRTU-KS2258025	22X58 Kartuş Sigorta Buşonu 25A / 22X58 Cylindrical Cartridge Fuse 25A	10	
İRTU-KS2258032	22X58 Kartuş Sigorta Buşonu 32A / 22X58 Cylindrical Cartridge Fuse 23A	10	
İRTU-KS2258040	22X58 Kartuş Sigorta Buşonu 40A / 22X58 Cylindrical Cartridge Fuse 40A	10	
İRTU-KS2258050	22X58 Kartuş Sigorta Buşonu 50A / 22X58 Cylindrical Cartridge Fuse 50A	10	
İRTU-KS2258063	22X58 Kartuş Sigorta Buşonu 63A / 22X58 Cylindrical Cartridge Fuse 63A	10	
İRTU-KS2258080	22X58 Kartuş Sigorta Buşonu 80A / 22X58 Cylindrical Cartridge Fuse 80A	10	
İRTU-KS2258100	22X58 Kartuş Sigorta Buşonu 100A / 22X58 Cylindrical Cartridge Fuse 100A	10	
İRTU-KS2258125	22X58 Kartuş Sigorta Buşonu 125A / 22X58 Cylindrical Cartridge Fuse 125A	10	



ÜRÜN GENEL ÖZELLİKLERİ

Kablo giriş plakaları, soketsiz kablo geçişleri için kullanılır. Kabloların geçişleri için 'conta plakası'na ufak bir delik açılması yeterlidir. Kompakt ve ince formu sayesinde sızdırmazlık özellikli kablo geçişleri sunar. Özellikle dar alanlarda çok sayıda kablunun geçişi için uygundur.

PRODUCT DESCRIPTION

Cable entry plates are used for cable without sockets. The product provides a sealed cable feed-through thanks to its compact and slim design. Thanks to its compact and slim form, it offers leak-proof cable passages. The feature of the product is that it is suitable for the passage of a large number of cables in tight spaces.

Kablo Geçiş Plakası (140 - 41 mm) / Cable Input Plate

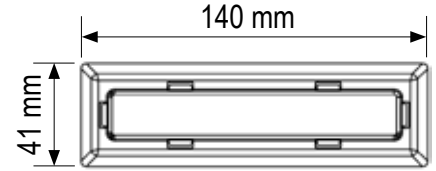
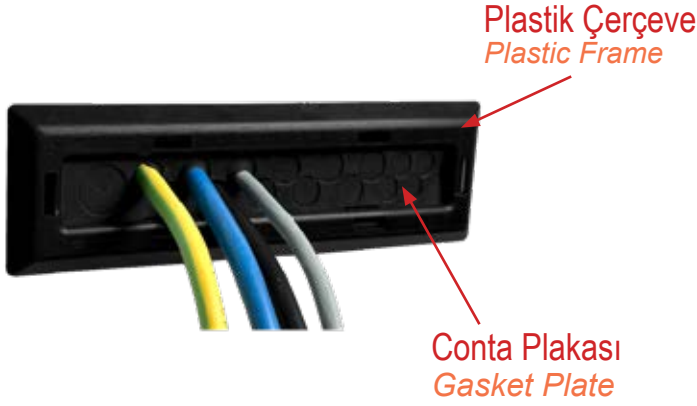

Plastik Çerçeve / Plastic Frame

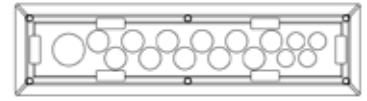

Conta Plakası / Gasket Plate



Ürün Kodu Code	Ürün Tanımı Product Name	Ölçüler Dimensions	Kutu Adet Box Qty	Birim Fiyat Unit Price
İRTU-KGC41140	Plastik Çerçeve	41 x 140mm	25	84,50 TL

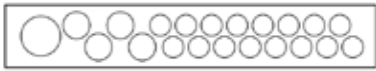

Ürün Kodu Code	Ürün Tanımı Product Name	Ölçüler Dimensions	Kablo Geçiş Ölçüleri Cable Passage Dimensions	Kutu Adet Box Qty	Birim Fiyat Unit Price
İRTU-KCP0010	Conta Plakası Gasket Plate	35 x 133 mm	16 x Ø6.5mm 4 x Ø8.5mm 1 x Ø12mm	25	77,00 TL
İRTU-KCP0011	Conta Plakası Gasket Plate	35 x 133 mm	4 x Ø6.5mm 11 x Ø8.5mm 1 x Ø12mm	25	77,00 TL



AVANTAJLAR

- Aletsiz montaj kolaylığı sağlar.
- Uygun maliyetli çözüm sağlar.
- Dar alanlarda kablo geçiş kolaylığı sağlar.
- Toz ve benzeri dış etkenlere karşı koruma sağlar.
- Plastik çerçeve içerisindeki 'Conta Plakası'nın değiştirilebilir olması, talebe uygun kablo çap ve adet için esneklik sağlar.

ADVANTAGES

- Provides ease of assembly without tools.
- Provides cost-effective solution.
- Allows easy cabling in confined spaces.
- Provides protection against dust and similar external factors.
- The replaceability of the 'Seal Plate' in the plastic frame allows for the cable diameter and quantities that can be used according to the demand.

Kablo Geçiş Plakası (140 - 41 mm) / Cable Input Plate

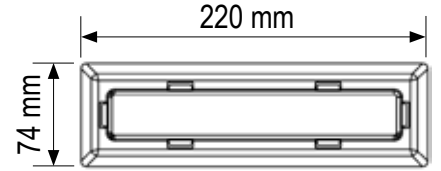
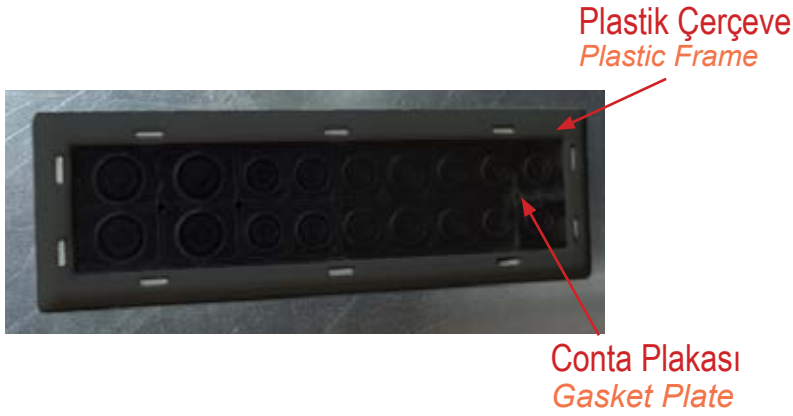

Plastik Çerçeve / Plastic Frame

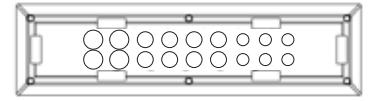

Conta Plakası / Gasket Plate



Ürün Kodu Code	Ürün Tanımı Product Name	Ölçüler Dimensions	Kutu Adet Box Qty	Birim Fiyat Unit Price
İRTU-KGC74220	Plastik Çerçeve	74 x 220mm	25	120,00

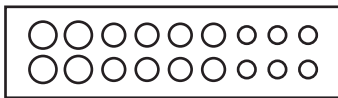

Ürün Kodu Code	Ürün Tanımı Product Name	Ölçüler Dimensions	Kablo Geçiş Ölçüleri Cable Passage Dimensions	Kutu Adet Box Qty	Birim Fiyat Unit Price
İRTU-KCP0022	Conta Plakası Gasket Plate	65 x 210 mm	6 x Ø10,5mm 8 x Ø13,5mm 4 x Ø16mm	25	117,00



DC Lamine busbar, elektrik ve elektronik ürünün güç cihazlarını bağlamak için uygulanır. Çok katmanlı bir iletken ve yalıtkan kompozit yapı ürünleridir. Lamine busbar kullanılan sistemlerde maliyetleri düşürür. Kapasitansı artırır ve endüktansı azaltır. Kablohata hatalarının önüne geçmeye yardımcı olur. Ayrıca, busbarların fiziksel yapısında ve mekanik tasarımında benzersiz kolaylıklar sağlar. Busbarlar projeye göre özel üretim yapılmakta ve bu sayede sistemin temel bir parçası olarak hareket etmektedir.

DC Laminated Busbar is applied to connect the power devices of the electrical and electronic product. It is a multilayer conductor and insulator composite structure products

Laminated Busbars reduce manufacturing costs, eliminate wiring errors, increase capacitance and lower inductance. The structure of busbars offers special features in mechanical design. They are produced specifically for the project and thus act as a primary element of the system.

Projeye göre özel üretim yapılmaktadır.
Manufacturing size can be done for clients specifically



IRTU ELEKTROMEKANİK SAN. ve TİC. LTD. ŞTİ.

netson

Elektromekanik San. Tic. Ltd. Şti.



Orta Mahalle Aktepe Caddesi Kınalıklar
Sokak No:19 Orhanlı - Tuzla - İstanbul



+90 216 487 54 65 (pbx)



+90 216 487 54 45



e-mail.irtu@irtugroup.com.tr



www.irtugroup.com.tr